

Hose Reel 884

Heavy duty hose reel for air, water, oil, diesel and grease.



This content is protected under copyright law, furnished for informational use only, and subject to change without notice. © Nederman Holding AB

2026-02-20

1/9

Hose Reel 884

- ✓ Fully protected inner mechanisms
- ✓ Strong, durable and highly corrosion resistant

- ✓ Adjustable outlet arm minimizes friction
- ✓ Easy service and cleaning.
- ✓ The recycled aluminium and composite drum reduces the environmental impact.

Heavy duty hose reel for air, water, oil, diesel and grease. Suitable for long and heavy hoses. Made of epoxy coated die cast aluminium. Ball bearings in drum and swivel

This content is protected under copyright law, furnished for informational use only, and subject to change without notice. © Nederman Holding AB

2026-02-20

2/9









Nederman





Hose Reel 884

Hose Reel 884

[ProductCertifications]	[ce]
[ProductMaterialrecycling]	100
[ProductConnectionHoseLength]	1
Colour	Grey
Weight (kg)	31,5
Corrosion resistance	Standard
Electric/Spring driven	Spring

Models

	Item no	Delivered with hose	Distribution hose diameter (mm)	Max working pressure (Mpa)	Max hose length	Media	Distribution hose length (m)	Diameter, connection hose (mm)
	30860084 ^[1]	[Without]	19	1,5	15			
	30860184 ^[2]	[Without]			20			
	30860284	[With]	12,5	1,5		Compressed air, Water	30	12,5
	30860484 ^[3]	[Without]		5	15	[diesel]		
	30860584	[With]	12,5	7,5		Oil	30	12,5
	30860684 ^[4]	[Without]	12,5	7,5	30	Oil		
	30860784	[With]	25	5		Oil	10	25
	30860884 ^[5]	[Without]	25	5	10	Oil		
	30860984	[With]	6	35		[grease]	25	6

	Item no	Delivered with hose	Distribution hose diameter (mm)	Max working pressure (Mpa)	Max hose length	Media	Distribution hose length (m)	Diameter, connection hose (mm)
	30861184 ^[3]	[Without]	19	5	15	Oil		
	30861084	[With]	19	5		Oil	15	19
	30861284	[With]	12,5	7,5		Oil	20	12,5
	30861384 ^[4]	[Without]	12,5	10	20	Oil		

This content is protected under copyright law, furnished for informational use only, and subject to change without notice. © Nederman Holding AB













2026-02-20

4/9

Nederman

Hose Reel 884

Models

	Item no	Delivered with hose	Distribution hose diameter (mm)	Max working pressure (Mpa)	Max hose length	Media	Distribution hose length (m)	Diameter, connection hose (mm)
	30861484	[With]	10	25		Water high pressure	25	10
	30861584 ^[6]	[Without]	10	25	25	Water high pressure		
	30861684	[With]	25	2		Water, Food	10	25
	30861784		19	2		Water, Food	15	19
	30861884	[With]	12,5	2		Water, Food	20	12,5
	30861984	[With]	25	1,5		Compressed air, Water	10	25
	30862084 ^[5]	[Without]	25	1,5	10	Compressed air, Water		
	30862184	[With]	19	1,5		Compressed air, Water	15	19
	30862284 ^[3]	[Without]	19	1,5	15	Compressed air, Water		
	30862384		12,5	1,5		Compressed air, Water	20	12,5
	30862484 ^[4]	[Without]	12,5	1,5	20	Compressed air, Water		
	30863484 ^[7]	[Without]			30			

	Item no	Delivered with hose	Distribution hose diameter (mm)	Max working pressure (Mpa)	Max hose length	Media	Distribution hose length (m)	Diameter, connection hose (mm)
	30863584	[With]	19	5		Oil	20	19

This content is protected under copyright law, furnished for informational use only, and subject to change without notice. © Nederman Holding AB

2026-02-20

5/9

Nederman

Hose Reel 884

Models

	Item no	Delivered with hose	Distribution hose diameter (mm)	Max working pressure (Mpa)	Max hose length	Media	Distribution hose length (m)	Diameter, connection hose (mm)
	30860384 ^[4]	[Without]		1,5	30	Compressed air, Water		

^[1] Without swivel. For 25 mm hose diameter max 10m hose length.

^[2] Without swivel

^[3] For 19 mm hose

^[4] For 12,5 mm hose

^[5] For 25 mm hose

^[6] For 10 mm hose

^[7] For 10 or 12,5 mm hose

Hose types













Hose type	[HoseSpecification]	[HoseTemperatureRange]	[HoseFittingDistribution]	[HoseFittingInlet]	[HoseConnectionDistribution]	[HoseConnectionInlet]
B	Cover in NBR/PVC and inner tube in NBR. Synthetic textile braid	-30 - 100	Male, chrome plated		Hose nipple + clip	Hose nipple 1/2" + clip
D	Cover in NBR/PVC and inner tube in NBR. Synthetic textile braid	-30 - 100	Male, chrome plated		Hose nipple + clip	Hose nipple + clip
E	Cover in NBR/PVC and inner tube in food grade quality NBR. Synthetic textile braid	-30 - 100	Male 60° cone, chrome plated	Female 60° cone, chrome plated	Male 60° cone	Male 60° cone
G	Cover and inner tube in synthetic rubber. Single steel braid	-40 - 155	Female 60° cone, chrome plated. With rubber hose grip	Female 60° cone, chrome plated	Male 60° cone	Male 60° cone
I	Cover and inner tube in SBR based rubber. Single steel braid	-40 - 100	Female 60° cone, chrome plated	Female 60° cone, chrome plated	Male 60° cone	Male 60° cone
J	Cover and inner tube in synthetic, oil resistant rubber. Double steel braid	-40 - 100	Female 60° cone, chrome plated	Female 60° cone, chrome plated	Male 60° cone	Male 60° cone

This content is protected under copyright law, furnished for informational use only, and subject to change without notice. © Nederman Holding AB

2026-02-20

6/9

Accessories

	Accessory	Item no
	Roller guide.	30341550
	Water gun in chromium plated brass. Max. temperature 95°C	30400110
	Water gun in stainless steel 316. Max. temperature 95°C	30400210
	Watergun EX	30400211
	Water gun in stainless steel 316. Max. temperature 95°C	30400310
	Air gun, standard.	30410110
	Swivelling coupling 3/8(m)-3/8(m)HP	30431310
	Swiv. coupling 3/8(m)-3/8(m) HP SS	30431410
	Swivl. coupl.1/2(m)-3/8(f) brass	30431510
	Swivl.coupl.1/2(m)-1/2(f) brass	30431610
	Swivel coupling 1/2(m)-3/4(f) bra	30431710
	Swivl. coupl. 1/2(m)-3/8(f) SS	30431810
	Swivl coupl. 1/2(m)-1/2(f) SS	30431910

This content is protected under copyright law, furnished for informational use only, and subject to change without notice. © Nederman Holding AB

2026-02-20

7/9

Accessories

	Accessory	Item no
	Swivl.coupl.1/2(m)-3/4(f) SS	30432010

	Accessory	Item no
	Pivoting Wall bracket FZB	30373667
	Inlet kit for hose reel 1/2"	30511550
	Inlet kit for hose reel 3/8" with ball valve 3/8", 3/8"-3/8" adapter and 1/4" - 3/8" adapter.	30511650
	Pivoting Wall bracket RF	30373668

This content is protected under copyright law, furnished for informational use only, and subject to change without notice. © Nederman Holding AB

2026-02-20

8/9

Nederman

Hose Reel 884

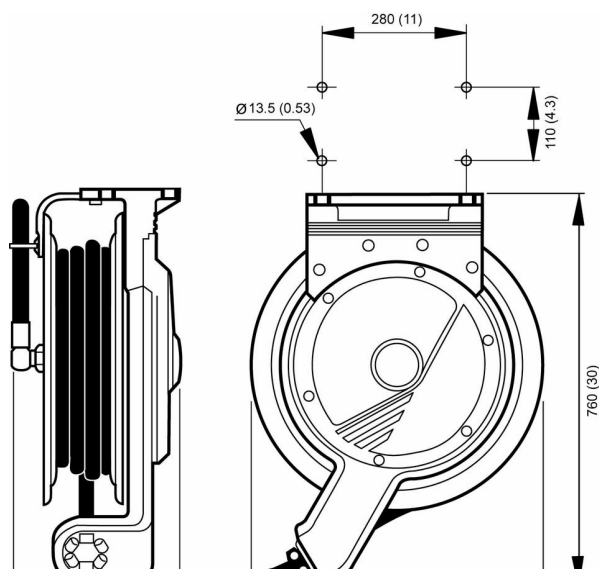

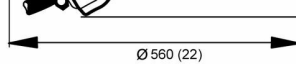
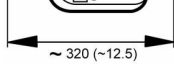

This content is protected under copyright law, furnished for informational use only, and subject to change without notice. © Nederman Holding AB