

# Bench Top Extraction Kits

Nederman Bench Top Extraction kits provide a quick and convenient solution for creating a fume-free workplace.















## Bench Top Extraction Kits

The Bench Top extraction kits include arm(s) with hood or nozzle, fan with speed control, and a multi-layer standard filter for particle and odor removal with integrated HEPA for high-efficiency filtration, along with hose, connection details, and table bracket. The speed of the fan is variably controlled by a speed controller. Complete with hoses and extraction hoods. The hood is made of clear plastic, which increases the visibility.

## Bench Top Extraction Kits









Certifications	CE
Power voltage (V)	220 - 240

## Models

	Item no	Frequency (Hz)	Electric plug	Weight (kg)	Power (kW)	Arm length (m)
	70508644 <sup>[1]</sup>	50 / 60	UK	13	0,12	
	70508744	50 / 60	UK	15	0,12	0,85
	70508244	50 / 60	UK	14	0,12	1,1
	70508344	50 / 60	UK	17	0,12	
	70508444	50 / 60	UK	15	0,12	
	70508544	50 / 60	UK	11	0,12	0,85
	67511734	50/60	UK	18	0,12	
	67505144	50/60		18	1,1	
	67505744	50/60	UK	18	0,12	
	67506344	50/60	UK	18	0,12	
	67511234	50/60	UK	18	0,12	
	67510734	50/60	UK	15	0,12	

<sup>[1]</sup> Max. airflow 42 m3/h

## Accessories

	Accessory	Item no
	Trolley for EK system to suit FX2 Ø50 (Down-Through)	67000151
	Trolley for EK system to suit FX2 Ø75 (Down-Through)	67000152
	FX-Combi hood-ORIGINAL-D50/75/100.	70500144
	FX-Dome hood-ORIGINAL-D50/75/100. Transparent dome hood, made of PET-G plastic, is designed to capture high dispersion contaminants. It can be attached directly on minihood, irrespective of arm size. The ergonomics of handle design on both sides of the hood make it easier to maneuver.	70376982
	FX-Metal hood-ORIG/CHEM-D50/75/100.	70500444
	FX-Flange hood-ORIGINAL-D50/75/100	70502844
	N3 fan Standard replacement filter 1,5 kg active carbon and 2,5 m2 HEPA 13 filter area.	70311427
	N3 fan replacement filter gas, 4 kg active carbon	70312427
	Pre filter EK 1000-3000 1 pcs.	70333007

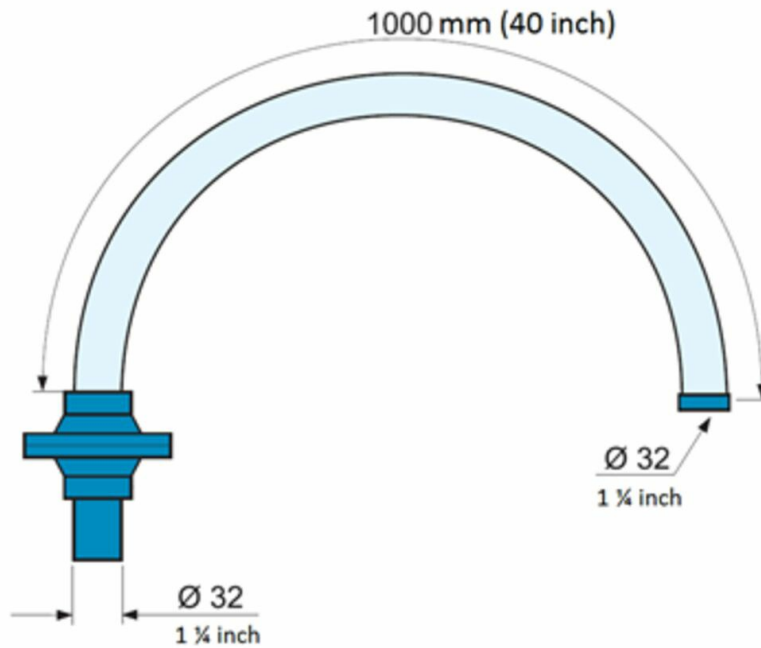

EK 500 Arm(s): 1 x FX 32 arm Hood(s): 1 x dome hood 1/2 Hose: Ø 45 mm (1 1/4 inch), 3000 mm (118 inch) length Max. airflow: 45 m3/h (26.5 cfm) EK 1000 Arm(s): 2 x FX 32 arm Hood(s): 2 x dome hood 1/2 Hose: Ø 45 mm (1 1/4 inch), 3000 mm (118 inch) length Max. airflow: 42 m3/h (25 cfm) EK 1500 Arm(s): 3 x FX 32 arm Hood(s): 3 x dome hood 1/2 Hose: Ø 45 mm (1 1/4 inch), 3000 mm (118 inch) length Max. airflow: 38 m3/h (22.4 cfm)

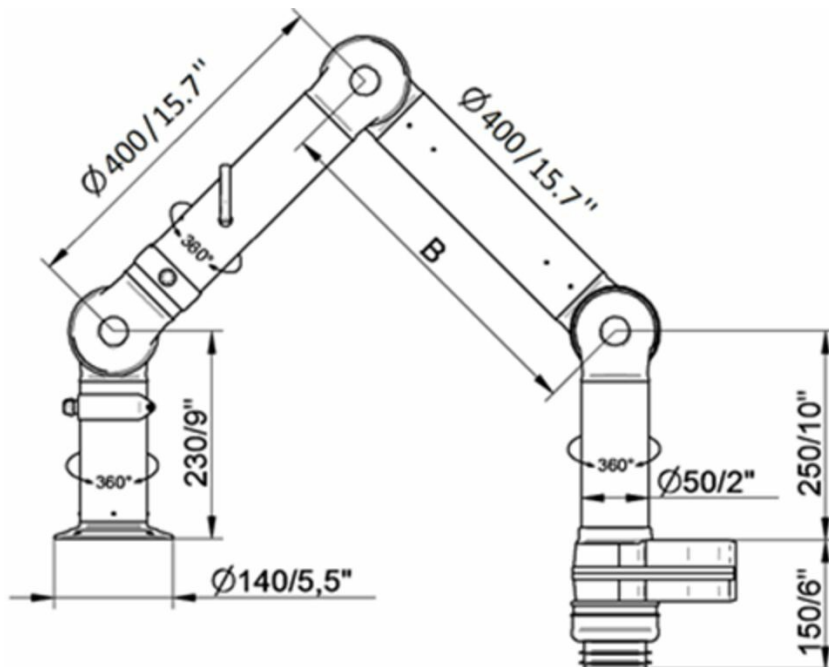

EK 2000 Arm(s): 1 x FX2 50 arm Hood(s): 1 x combination hood Hose: Ø 75 mm (3 inch), 3000 mm (118 inch) length Max. airflow: 100 m3/h (58.8 cfm) EK 2500 Arm(s): 2 x FX2 50 arm Hood(s): 2 x mini hood Hose: Ø 75 mm (3 inch), 3000 mm (118 inch) length Max. airflow: 75 m3/h (44 cfm)

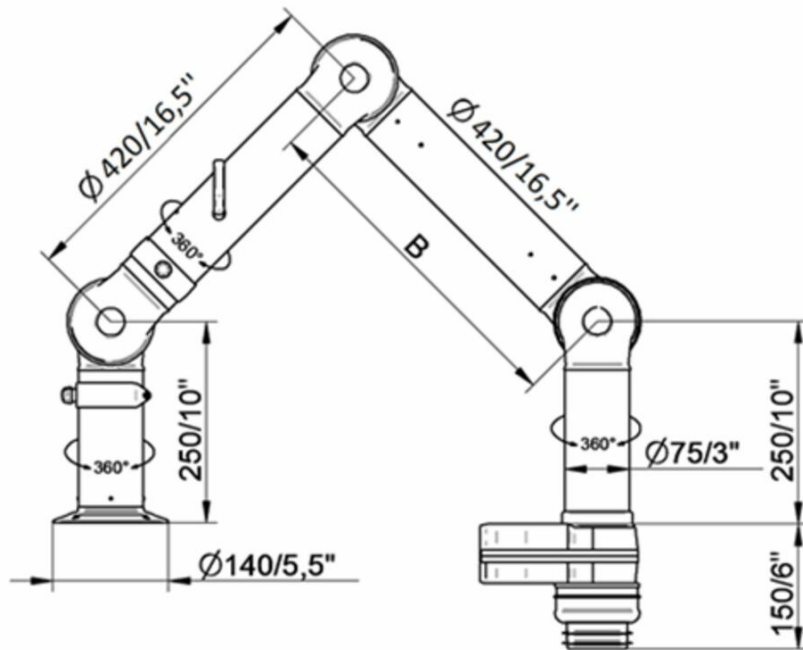

EK 3000 Arm(s): 1 x FX2 75 arm Hood(s): 1 x mini hood Hose: Ø 100 mm (4 inch), 3000 mm (118 inch) length Max. airflow: 150 m<sup>3</sup>/h (88.3 cfm)