

FMC筒式除尘器

紧凑型滤芯用于解决广泛的行业中的灰尘问题



FMC筒式除尘器

- ✓ 滤筒有各种各样的材料可选, 适合大多数应用以及各种类型的粉尘种类和数量。
- ✓ 模块化的紧凑设计意味着他们可以安装接近粉尘的来源,从而减少能源消耗。
- ✓ FMC除尘器的滤筒更换简单方便
- ✓ 经济高效节能的过滤控制
- ✓ 快速释放废物箱

FMC的滤芯过滤器系列提供许多经营效益由于其紧凑的设计和uniclean®系统。uniclean®墨盒的特殊设计保证了一致和有效的清洗。过滤筒可在两个不同的长度(L型或A型)。

FMC的过滤器是专为1200-21000 m³/h含不同类型之间的灰尘的风量。FMC的过滤器可以安装不同类型的滤筒、垂直放置防止灰尘积聚在过滤材料。该过滤器设计为室外放置作为标准设计用于顶部固定风扇。聚酯标准滤芯 CA100: 最大10 g/m³. 精细到粗颗粒灰尘。纤维素滤芯 CA175: 最大1 g/m³. 冷烟尘。

入风口和出风口尺寸 160, 250, 315, 400, 500 or 560毫米, 空气进风口适用于耐磨板。初级分离室的选择与穿孔的屏幕。压差测量和清洗系统控制 DFC-8M, 能量补给 230 V - 50 Hz, 110V - 60 Hz.



FMC筒式除尘器

证书	CE
压缩空气需求	6 bar
安装	室内, 室外
材料	镀锌薄钢板
适用于易爆粉尘	False
清灰方式	脉冲清灰
应用	粉尘, 烟气
灰斗容量	50
性能(最大风量m ³ /h)	21000













模型

	项目编号	除尘器类型	滤芯数量
	FMC200-2Ls	滤筒式过滤器	8
	FMC200-2Lc	滤筒式过滤器	8
	FMC200-4Ls	滤筒式过滤器	16
	FMC200-4Lc	滤筒式过滤器	16
	FMC200-6Ls	滤筒式过滤器	24
	FMC200-6Lc	滤筒式过滤器	24
	FMC200-8Ls	滤筒式过滤器	32
	FMC200-8Lc	滤筒式过滤器	32
	FMC200-2As	滤筒式过滤器	8
	FMC200-2Ac	滤筒式过滤器	8
	FMC200-4As	滤筒式过滤器	16
	FMC200-4Ac	滤筒式过滤器	16
	FMC200-6As	滤筒式过滤器	24













模型

	项目编号	除尘器类型	滤芯数量
	FMC200-6Ac	滤筒式过滤器	24
	FMC200-8As	滤筒式过滤器	32
	FMC200-8Ac	滤筒式过滤器	32









配件

	配件	项目编号
	Damper type NFUS3	5501395
	Discharge bin 50 l with wheels	5501274
	Discharge bin 50 l without wheels	5501273
	Discharge bin 100 l with wheels	5501275
	Adaptor for bin with bag	5505033
	Adaptor for 50 l bin with bag incl. fitting	5505034
	Adaptor for 100 l bin with bag incl. fitting	5505035
	Hose set for bin balancing	5505041
	Single backpack for 4 modules	5509660
	Single backpack for 8 modules round inlet from the top pos L	5501169
	Double backpack for 4 modules	5509661
	DUAL silencer for FM600 series fan with air grille	5501813
	DUAL silencer for FM6800 series fan with air grille	5501830

配件

	配件	项目编号
	DUAL silencer for FM1000 series fan with air grille	5501854
	DUAL silencer for FM600 series fan with air grille and rain cover	5501814
	DUAL silencer for FM6800 series fan with air grille and rain cover	5501832
	DUAL silencer for FM1000 series fan with air grille and rain cover	5501855
	DUAL silencer for FM600 series fan with flanged outlet for duct connection	5501815
	DUAL silencer for FM6800 series fan with flanged outlet for duct connection	5501833
	DUAL silencer for FM1000 series fan with flanged outlet for duct connection	5501856
	Isolation box for FM pressure tank, 2 modules	5501317
	Isolation box for FM pressure tank, 4 modules	5501318
	Isolation box for FM pressure tank, 6 modules	5501319
	Isolation box for FM pressure tank, 6 modules	5501320
	Level sensor with beacon, 230V	5504475
	Cable gland M40 for levelsensor	5512245

配件

	配件	项目编号
	Noise enclosure for FM600 fan	5501783
	Noise enclosure for FM800 fan	5501784
	Noise enclosure for FM1000 fan	5501799
	Platform for FM filter with 2 modules	5501356
	Platform for FM filter with 4 modules	5501357
	Platform for FM filter with 6 modules	5501358
	Platform for FM filter with 8 modules	5501359
	Platform for FM filter with 6 modules, single outlet hopper	5501373
	Platform for FM filter with 8 modules, single outlet hopper	5501374

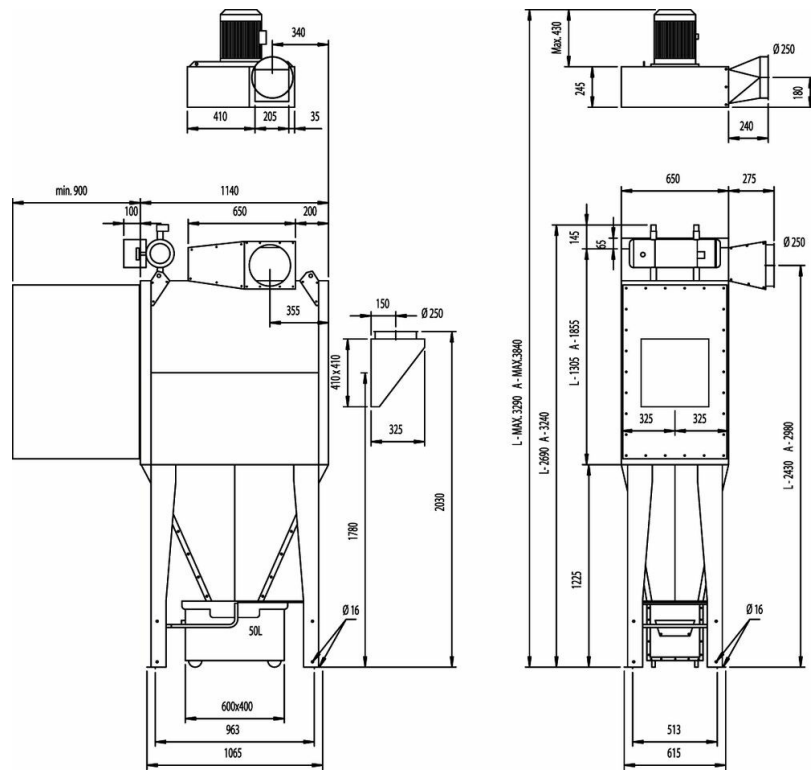

FMC version 2L and 2A shown with 50L bin

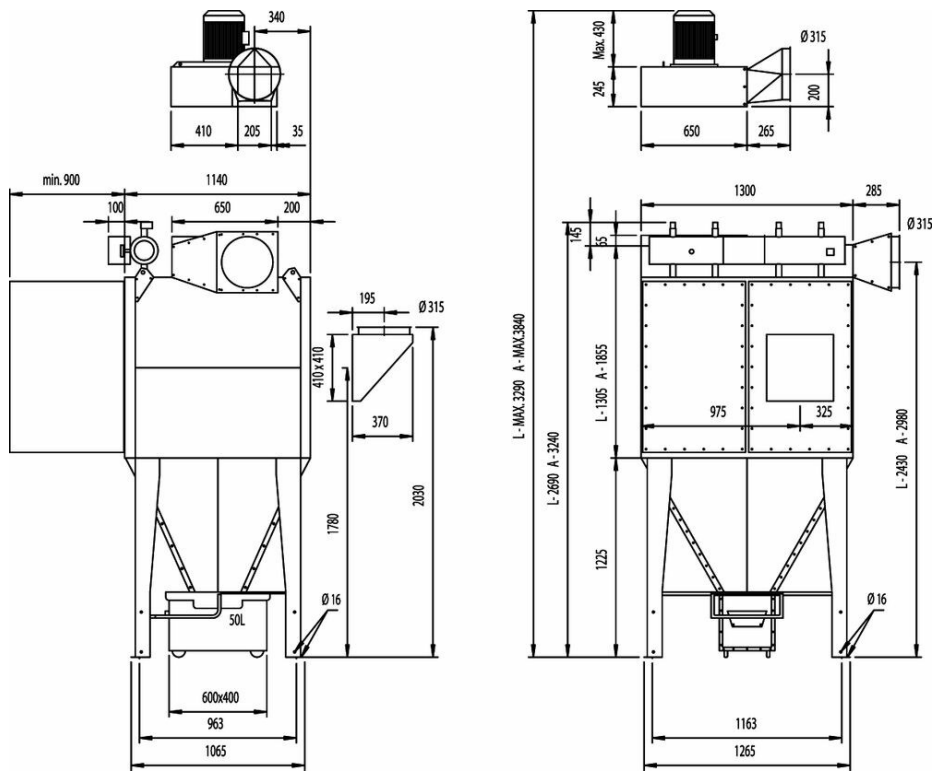

FMC version 4L and 4A shown with 50L bin

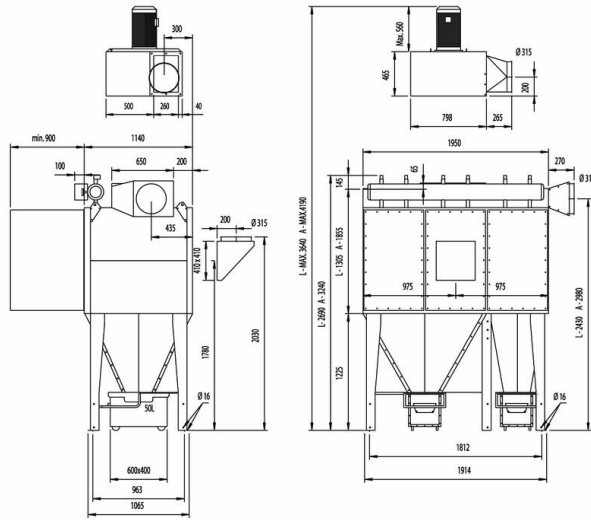

FMC version 6L and 6A shown with 50L bin

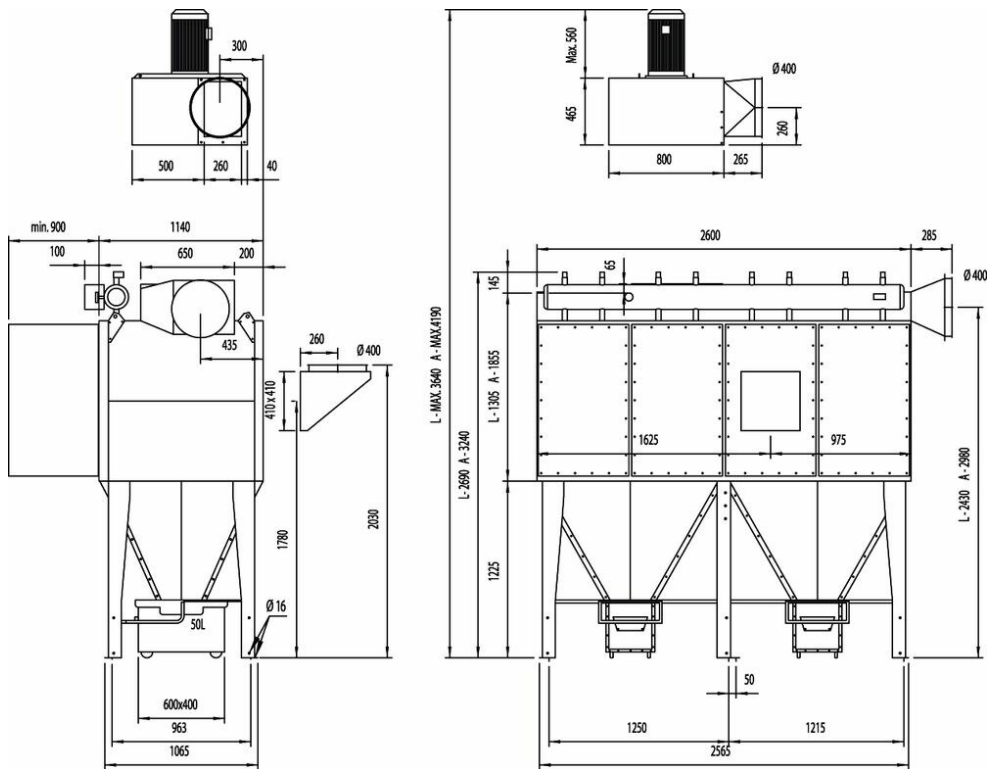

FMC version 8L and 8A shown with 50L bin