

Industristøvsuger 570A, konfigurerbar

En kraftig støvsuger med fremragende højt vakuum stil støvsugning over lange horisontale og vertikale afstande.



Industristøvsuger 570A, konfigurerbar

- ✓ Silo system with large wheels
- ✓ Suitable for heavy and or abrasive material
- ✓ Robust and efficient self-cleaning filter

The configuration of modules will be similar to 570A which are aimed for the toughest applications, for example handling a lot of abrasive and heavy material. The robustness of the unit and the power from the reliable ejector makes the unit very suitable for many applications where many industrial vacuum cleaners can not be used. For example to collect blasting material in blasting hall, sand recovery in foundries etc.

Your unit can be configured to meet your specific demands. Different ejectors can be used depending on the demand but also the availability of compressed air. The ejector can be placed on a mobile silo with filter, with wheels and forklift slots. Nederman has a range of different discharge valves that can be fitted to the silo for easy discharge of the collected material. If handling larger quantities of material, Nederman recommends using a pre separator before the vacuum unit. See Nederman Engineering Guide for more information.

Use modules linked to 570A, configurable only. You may only choose ejectormodule, filtermodule, silomodule and discharge valve

1. Select ejectormodule depending on required vacuum and air flow.
2. Select filtermodule depending on filter capacity.
3. Select silomodule.
4. Select discharge valve.
5. Select cleaning equipment.

Choose how to control your butterfly valve:

1. Electric controlled - You need a namur valve, solenoid valve recommended for the ejector size you choose and a control box.
2. Air controlled - You need a namur valve.







Hose for air supply to the namur valve is not supplied by Nederman.

Control system with many different functions is available as an accessory
Ensure you meet all requirements for your modules.

Industristøvsuger 570A, konfigurierbar

Cerifikat	CE
Metode for filterrensning	Trykluft
Applikation	Støv, Granulat, Grit, Spån













Modeller

	Item number	Trykluftbehov	Maks. luftmængde (m ³ /h)	[ItemMaxVaccum]	Vægt (kg)	Type af filter	Antal filter
	43051000 ^[1]	4,3 Nm ³ /min @ 7 bar	330 Nm ³ /h	-68	18		
	43051001 ^[1]	5,3 Nm ³ /min @ 7 bar	318 Nm ³ /h	-78	18		
	43051002 ^[2]	5,4 Nm ³ /min @ 7 bar	690 Nm ³ /h	-48	18		
	43051003 ^[2]	8,6 Nm ³ /min @ 7 bar	660 Nm ³ /h	-68	18		
	43162101				40	Stavfilter	70
	43164101				55	Stavfilter	70
	43470034				80		













^[1] Recommended with filtermodule 43162101

^[2] Recommended with filtermodule 43164101













Tilbehør

	Accessory	Item number
	Tømmeventil, manuel	43630001
	Tømmeventil med kontravægt	43630200
	Tømmeventil, pneumatisk	43630100
	Klemmeventil DN65	43632001
	Klemmeventil DN80	43632100
	Manuel butterflyventil sæt, MFC	43630400
	Slange PU12-51 L=10m	43832600
	Slange PU12-51 L=5m	43832500
	Slange PU12-51 L=20m	43832300
	Slange PU12-51 L=7,5m med kobling	43832102
	Slange PU12-51 L=10m med kobling	43832200
	Slange PU12-63 L=5m	43833200
	Slange PU12-63 L=10m	43833001













Tilbehør

	Accessory	Item number
	Slange PU12-63 L=20m	43833100
	Slange PU12-76 L=10m	43834200
	Slange PU12-76 L=20m	43834300
	Montageplade f/0802010 +0801020	43690001
	Kontrolsystem for ejektorer	43220034
	BLI EX	40375269
	Rengøringsæt komplet d51/500	42932100
	Rengøringsæt komplet d51/400	42932800
	Rengøringsæt komplet d51/400	42932300
	Gulvmundstykke d51/500	43840150
	Gulvmundstykke d51/400/65	43840250
	Børste gulvmundstykke d51/400	43840550
	Håndmundstykke, hård børste ø51	43860001





Tilbehør

	Accessory	Item number
	Tandet mundstykke ø51	43861001
	Konisk mundstykke ø51	43862001
	Vinklet støvsugerør d51 antistatisk	43842150
	Støvsugerør d51 PEHD-el 1m	43842001
	Bulkmundstykke d51 m/håndtag	43850150
	Bulkmundstykke d51	43850001
	Skrabemundstykke ø51 l=1000	43851150
	Skrabemundstykke ø51 l=500	43851050
	Spån mundstykke Ø 50 mm	40150030
	Gulvmundstykke d63/500	43840400
	Bulkmundstykke d63	43850050
	Falskluftmundstykke ø63, luge	43850051
	Bulkmundstykke d63 m/håndtag	43850200

Tilbehør

	Accessory	Item number
	Skrabemundestykke ø63 L = 1000	43851200
	Vinklet støvsugerør aluminium d63	43843050
	Drejeled stål d63	43843100
	Støvsugerør aluminium d63	43843001
	Skrabemundestykke ø63 L = 500	43851100
	Bulkmundestykke d76	43850100
	Bulkmundestykke d76 m/håndtag	43850250
	Skrabemundestykke ø76 l=1000	43851250
	Slangereduktion, konisk ø76-63	43880350
	Reduktion konisk ø76-51	43880300
	Slangereduktion, konisk ø63-51	43880250
	Slangetilslutning ø63	43880100
	Slangetilslutning ø50	43880050

Tilbehør

	Accessory	Item number
	Slangetilslutning konisk ø76	43880150
	Styring S for NE 22-76	43220001
	Styring S for NE 22-76, uden kontrolboks	43220026
	Styring S for NE86-96, uden kontrolboks	43222008
	Gulvmundstykke d63/600	43840450

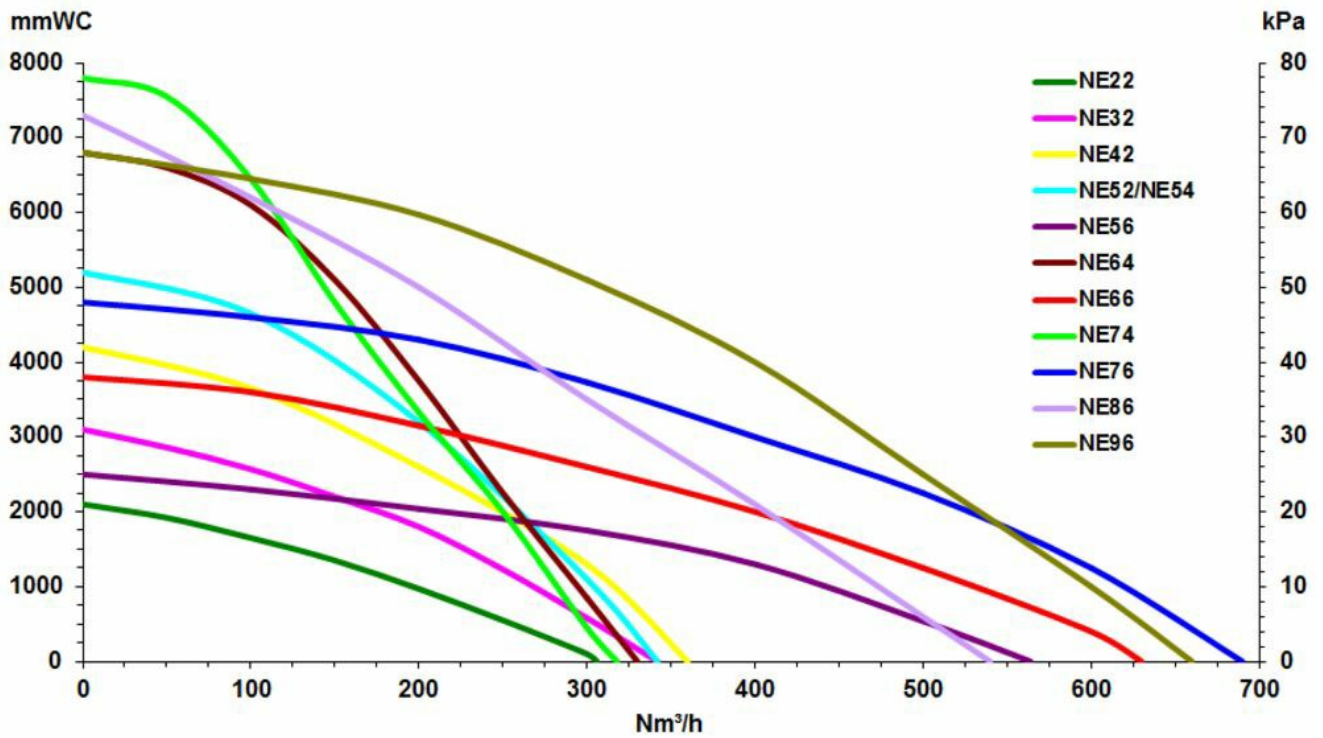

Air Powered ejectors All performance data are based on 7 bar supply pressure

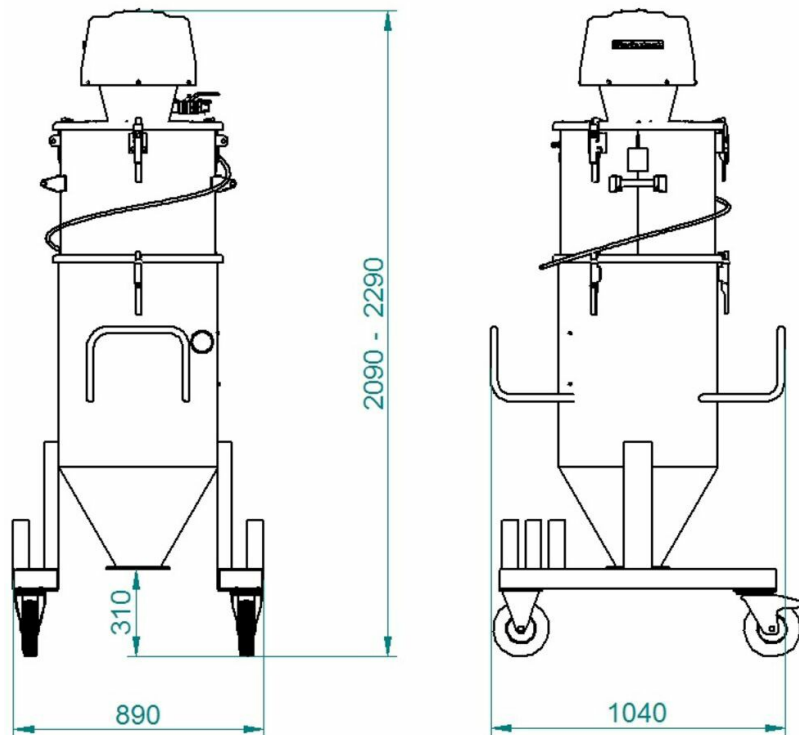

The height of the configuration is depending on filtermodule choosen.

Ejector/Hose dimension	ø51mm	ø63mm	ø76mm
NE64	2	2,4	N/A
NE74	2,3	2,7	N/A
NE76	1,7	2,7	3,6
NE96	2,6	3,6	4,9

Capacity (tonne/hour) with Blasting media 2,4kg/liter and 20m hose