

570A, Ayarlanabilir

Uzun yatay ve dikey mesafeler üzerinde emiş için mükemmel yüksek vakumlu güçlü bir toz toplayıcı



570A, Ayarlanabilir

- ✓ Geniş tekerlekli silo sistemi
- ✓ Yoğun ve/veya aşındırıcı maddeler için uygundur.
- ✓ Yoğun ve/veya aşındırıcı maddeler için uygundur.

Modüllerin konfigürasyonu, en zorlu uygulamaları, örneğin çok fazla aşındırıcı ve ağır malzeme taşıma gibi işlemleri hedefleyen 570A'ya benzer olacaktır. Ünitenin dayanıklılığı ve güvenilir ejektörden gelen güç üniteyi birçok endüstriyel vakumlu temizleyicinin kullanılmadığı birçok uygulama için çok uygun bir duruma getirir. Örneğin kumlama salonunda kumlama malzemesi toplamak, dökümhanelerde kum geri kazanımı vb. gibi.

Üniteniz özel taleplerinizi karşılayacak şekilde yapılandırılabilir. İsteğe bağlı olarak ve aynı zamanda sıkıştırılmış havanın bulunmasına bağlı olarak farklı ejektörler kullanılabilir. Ejektör tekerlekli ve forklift yuvaları olan, filtreye sahip hareketli bir silo üzerine yerleştirilebilir. Nederman, toplanan maddelerin kolay boşaltılması için siloya takılabilen farklı boşaltma vanaları yelpazesine sahiptir.

Daha büyük miktarda malzeme kullanıyorsanız, Nederman vakum ünitesinden önce bir ön ayırıcı kullanmanızı önerir. Daha fazla bilgi için bkz. Nederman Mühendislik Kılavuzu.

Sadece yapılandırılabilir 570A'ya bağlı modülleri kullanın. Sadece ejektör modülü, filtre modülü, silo modülü ve boşaltma vanası seçebilirsiniz.

1. Gerekli vakum ve hava akışına bağlı olarak ejektör modülünü seçin.
2. Filtre kapasitesine bağlı olarak filtre modülünü seçin.
3. Silo modülünü seçin.
4. Boşaltma vanasını seçin.
5. Temizlik donanımlarını seçin.

Kelebek vananın nasıl kontrol edileceğini seçin:

1. Elektrik kontrollü - Seçtiğiniz ejektör boyutu ve bir kontrol kutusu için tavsiye edilen bir namur vanaya, selenoid vanaya ihtiyacınız vardır.
2. Hava kontrollü - Bir namur vanaya ihtiyacınız vardır.

Namur vanasına hava beslemesi için hortum Nederman tarafından sağlanmamaktadır.







Aksesuar olarak birçok farklı fonksiyona sahip kontrol sistemi mevcuttur

Modülleriniz için tüm gereksinimleri karşıladığınızdan emin olun.

570A, Ayarlanabilir

| | |
|------------------------|--------------------------------------|
| Sertifikalar | CE |
| Filtre temizlik metodu | [CompressedAir] |
| [ProductApplication] | [dust], [granulate], [grit], [swarf] |













Models

| | Item number | [ItemCompressedAirRequirement] | [ItemMaxAirFlow] | [ItemMaxVaccum] | Ağırlık (kg) | Filtre türü | Filtre adedi |
|---|-------------------------|----------------------------------|------------------------|-----------------|--------------|-------------|--------------|
|  | 43051000 ^[1] | 4,3 Nm ³ /min @ 7 bar | 330 Nm ³ /h | -68 | 18 | | |
|  | 43051001 ^[1] | 5,3 Nm ³ /min @ 7 bar | 318 Nm ³ /h | -78 | 18 | | |
|  | 43051002 ^[2] | 5,4 Nm ³ /min @ 7 bar | 690 Nm ³ /h | -48 | 18 | | |
|  | 43051003 ^[2] | 8,6 Nm ³ /min @ 7 bar | 660 Nm ³ /h | -68 | 18 | | |
|  | 43162101 | | | | 40 | [NCF] | 70 |
|  | 43164101 | | | | 55 | [NCF] | 70 |
|  | 43470034 | | | | 80 | | |













^[1] Filtre modülü 43162101 ile tavsiye edilir.

^[2] Filtre modülü 43164101 ile tavsiye edilir













Accessories

| | Accessory | Item number |
|---|--|-------------|
|  | Boşaltma vanası manuel | 43630001 |
|  | disk vanası denge ağırlıklı | 43630200 |
|  | Boşaltma vanası Pnömatik | 43630100 |
|  | Esnek vana DN65 | 43632001 |
|  | Esnek vana DN80 | 43632100 |
|  | manuel kelebek vana kit, MFC | 43630400 |
|  | Hortum PU12-51 U=10m | 43832600 |
|  | Hortum PU12-51 U=5m | 43832500 |
|  | Hortum PU12-51 U=20m | 43832300 |
|  | Hortum PU12-51 U=7,5m w. Kaplin | 43832102 |
|  | Hortum PU12-51 U=10m kavramalara sahip | 43832200 |
|  | Hortum PU12-63 U=5m | 43833200 |
|  | Hortum PU12-63 U=10m | 43833001 |













Accessories

| | Accessory | Item number |
|---|-------------------------------------|-------------|
|  | Hortum PU12-63 U=20m | 43833100 |
|  | Hortum PU12-76 U=10m | 43834200 |
|  | Hortum PU12-76 U=20m | 43834300 |
|  | Montaj plakası 0802010+0801020 için | 43690001 |
|  | Çıkarıcılar için kontrol sistemi | 43220034 |
|  | BLI (Kutu seviye göstergesi) EX | 40375269 |
|  | Emiş donanımı komple d51/500 | 42932100 |
|  | Emiş donanımı komple d51/400 | 42932800 |
|  | Emiş donanımı komple d51/400 | 42932300 |
|  | Zemin emiş başlığı d51/500 | 43840150 |
|  | Zemin emiş başlığı d51/400/65 | 43840250 |
|  | fırça emiş başlığı d51/400 | 43840550 |
|  | el emiş h sert fırça d51 | 43860001 |





Accessories

| | Accessory | Item number |
|---|------------------------------------|-------------|
|  | el emiř bařlıđı pp d51 | 43861001 |
|  | konik nozulu d51 | 43862001 |
|  | emiř borusu Dirsek d51 anti statik | 43842150 |
|  | emiř borusu d51 PEHD-el 1m | 43842001 |
|  | Gulper bařlıđı d51 kollu | 43850150 |
|  | Gulper bařlıđı d51 | 43850001 |
|  | Kazıma aleti d51 I1000 | 43851150 |
|  | Kazıma aleti d51 I500 | 43851050 |
|  | nozulu Talař D=50mm | 40150030 |
|  | Zemin emiř bařlıđı d63/500 | 43840400 |
|  | Gulper bařlıđı d63 | 43850050 |
|  | Gulper bařlıđı d63 kapak | 43850051 |
|  | Gulper bařlıđı d63 kollu | 43850200 |

Accessories

| | Accessory | Item number |
|---|----------------------------------|-------------|
|  | Kazıma aleti d63 l1000 | 43851200 |
|  | emiş borusu Dirsek Alüminyum d63 | 43843050 |
|  | dönme çelik d63 | 43843100 |
|  | emiş borusu Alüminyum d63 | 43843001 |
|  | Kazıma aleti d63 l500 | 43851100 |
|  | Gulper başlığı d76 | 43850100 |
|  | Gulper başlığı d76 kollu | 43850250 |
|  | Kazıma aleti d76 l1000 | 43851250 |
|  | Hortum kırmızı konik d76-63 | 43880350 |
|  | kırmızı konik d76-51 | 43880300 |
|  | Hortum kırmızı konik d63-51 | 43880250 |
|  | Hortum konnektörü d63 | 43880100 |
|  | Hortum konnektörü d50 | 43880050 |

Accessories

| | Accessory | Item number |
|---|--|-------------|
|  | Hortum bağlantısı konik d76 | 43880150 |
|  | NE 22-76 için kontrol S | 43220001 |
|  | NE 22-76 için kontrol S, kontrol kutusuz | 43220026 |
|  | NE86-96 için kontrol S, kontrol kutusuz | 43222008 |
|  | Zemin emiş başlığı d63/600 | 43840450 |

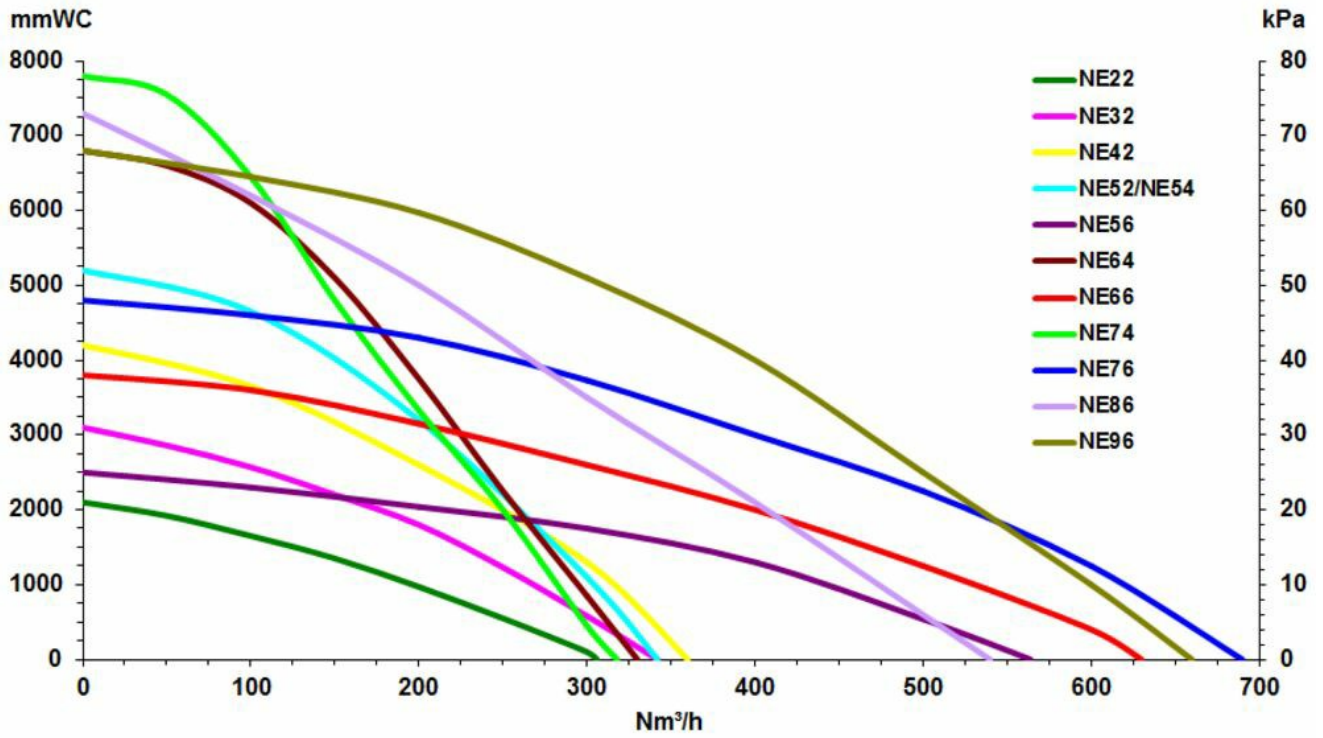

Air Powered ejectors All performance data are based on 7 bar supply pressure

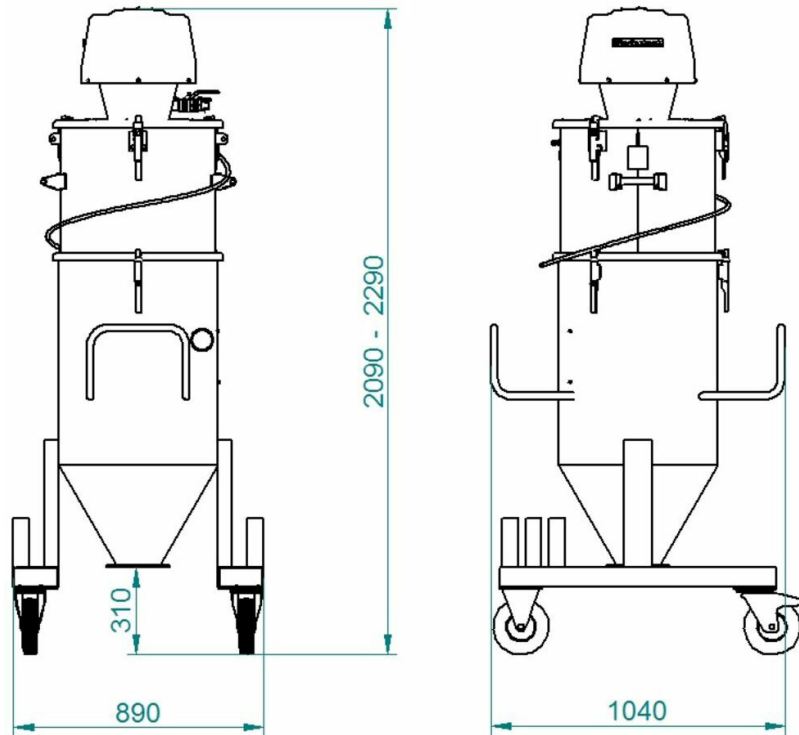

The height of the configuration is depending on filtermodule choosen.

| Ejector/Hose dimension | ø51mm | ø63mm | ø76mm |
|------------------------|-------|-------|-------|
| NE64 | 2 | 2,4 | N/A |
| NE74 | 2,3 | 2,7 | N/A |
| NE76 | 1,7 | 2,7 | 3,6 |
| NE96 | 2,6 | 3,6 | 4,9 |

Capacity (tonne/hour) with Blasting media 2,4kg/liter and 20m hose