

471A configurable

A powerful dust collector, excellent high vacuum for suction over long horizontal and vertical distance

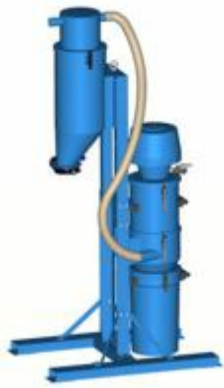

This content is protected under copyright law, furnished for informational use only, and subject to change without notice. © Nederman Holding AB

471A configurable

- ✓ Robust and efficient self-cleaning filter
- ✓ Very powerful and reliable ejector as vacuum producer
- ✓ Suitable for heavy and/or abrasive material
- ✓ Control system with many different functions is available as an accessory

Nederman Pre-separation and Vacuum Transportation Systems pre-separate and discharge dust and granulated material during vacuuming and vacuum transport.

A system can handle dry material like cement, fertilizers, grit, sand, as well as wet material. Collected material can be discharged into tanks, containers, big-bags, on to conveyor belts, escalators etc.

The configuration of modules will be similar to 471A which are aimed for the toughest applications, for example handling a lot of abrasive and heavy material. The robustness of the unit and the power from the reliable ejector makes the unit very suitable for many applications where many industrial vacuum cleaners can not be used. For example to collect blasting material in blasting hall, sand recovery in foundries etc.

Your unit can be configured to meet your specific demands. Different ejectors can be used depending on the demand but also the availability of compressed air. The ejector can be placed on a stationary silo with filter.

Nederman has a range of different discharge valves that can be fitted to the silo for easy discharge of the collected material.

If handling larger quantities of material and in order to make the material handling more effective Nederman recommends using a pre separator before the vacuum unit. The 471A is a complete unit including a pre separator.

To configure your 471A you may only choose modules listed in this document and with mfc (module for configuration) in title.

1. Select ejectormodule depending on required vacuum and air flow.
2. Select filtermodule depending on filter capacity.
3. Select silomodule depending on disposal option.
4. Select disposal option, container or discharge valve with plastic bag.
5. Select coarse grain separator.
6. Select silo.
7. Select discharge valve.
8. Select frame.
9. Select hose for connection between vacuum cleaner and separator.
10. Select cleaning equipment.

Choose how to control your butterfly valve:

1. Electric controlled
 - You need a namur valve, solenoid valve recommended for the ejector size you choose and a suitable control box.
2. Air controlled
 - You need a namur valve.

Hose for air supply to the namur valve is not supplied by Nederman.

Ensure you meet all requirements for your modules.

This content is protected under copyright law, furnished for informational use only, and subject to change without notice. © Nederman Holding AB

2026-06-11

2/11

Nederman

471A configurable

471A configurable

[ProductCertifications]	[ce]
[ProductFiltercleaningMethod]	[CompressedAir]
[ProductFilterArea]	1,6

This content is protected under copyright law, furnished for informational use only, and subject to change without notice. © Nederman Holding AB





2026-06-11











3/11

Nederman

471A configurable

Models

	Item no	[ItemCompressedAirRequirement]	[ItemMaxAirFlow]	[ItemMaxVaccum]	[ItemWeight]	[ItemFilterType]	[ItemNbrofFilterElements]
	43051004	7 bar and 3,0 Nm ³ /min	342 Nm ³ /h	-52	13		
	43051005	7 bar and 4,3 Nm ³ /min		-68	13		
	43051006	7 bar and 5,3 Nm ³ /min		-78	13		
	43160101				22	[NCF]	36

	Item no	[ItemCompressedAirRequirement]	[ItemMaxAirFlow]	[ItemMaxVaccum]	[ItemWeight]	[ItemFilterType]	[ItemNbrofFilterElements]
							
	43420026				12		
	43420027				12		
	43640001				3		
	43640003 ^[1]				3		
	43751039 ^[2]				55		
	43751040 ^[3]				50		
	43413026				24		
	43332001						
	43334001						

This content is protected under copyright law, furnished for informational use only, and subject to change without notice. © Nederman Holding AB



2026-06-11

4/11

Nederman

471A configurable

Models

	Item no	[ItemCompressedAirRequirement]	[ItemMaxAirFlow]	[ItemMaxVaccum]	[ItemWeight]	[ItemFilterType]	[ItemNbrofFilterElements]
	43550002 ^[4]				15		
	43550005 ^[5]				15		

^[1] Recommended with 43630100

^[2] Fits blastpots up to 680mm width. Max height 2,3m.

^[3] Fits blastpots up to 560mm width. Max height 2,3m.

^[4] Suitable for suction hose PU12 Ø51mm with coupler 40377028

^[5] Flap valve 43885001 can be used on the inlet

This content is protected under copyright law, furnished for informational use only, and subject to change without notice. © Nederman Holding AB











2026-06-11



5/11

Nederman

471A configurable

Accessories

	Accessory	Item no
	Discharge valve manual	43630001
	Manual butterfly valve kit, MFC	43630400
	Pinch valve DN65	43632001
	Pinch valve DN80	43632100
	Pinch valve DN100	43632200
	Disch valve w/counterwt	43630200
	Discharge valve pneum	43630100
	Discharge valve Linatex d100 set w/	43630300
	Control System for Ejectors	43220034
	ATEX-approved bin level indicator providing safe monitoring in hazardous environments with detailed user manual instructions.	40375269

	Accessory	Item no
	Plastic bag S50 - 25pcs 630x800	43650104
	Joint sleeve 65	40377028
	Joint sleeve 76mm, hoseclamp included	40130990

This content is protected under copyright law, furnished for informational use only, and subject to change without notice. © Nederman Holding AB













2026-06-11

6/11













Nederman

471A configurable











Accessories

	Accessory	Item no
	Joint sleeve d75-89/d53-63mm	43884464
	Joint sleeve d65-75	43884463
	Hose PU12-51 L=10m	43832600
	Hose PU12-51 L=5m	43832500
	Hose PU12-51 L=20m	43832300
	Hose PU12-51 L=7,5m w. couplings	43832102
	Hose PU12-51 L=10m w. couplers	43832200
	Hose PU12-63 L=5m	43833200
	Hose PU12-63 L=10m	43833001
	Hose PU12-63 L=20m	43833100
	Suct equip compl d51/500	42932100
	Suct equip compl d51/400	42932800
	Suct equip compl d51/400	42932300

Accessories

	Accessory	Item no
	Floor suct head d51/500	43840150
	Floor suct head d51/400/65	43840250
	Brush suct head d51/400	43840550
	Hand suct h stiff brush d51	43860001
	Hand suct head pp d51	43861001
	Conical nozzle d51	43862001
	Suct pipe bend d51	43842150
	Suction pipe d51 PEHD-el 1m	43842001
	Gulper head d51 w/handle	43850150
	Gulper head d51	43850001
	Scraping tool d51 I1000	43851150
	Scraping tool d51 I500	43851050
	Nozzle swarf D=50mm	40150030

Accessories

	Accessory	Item no
	Floor suct head d63/500	43840400
	Gulper head d63	43850050
	Gulper head d63 hatch	43850051
	Gulper head d63 w/handle	43850200
	Scraping tool d63 l1000	43851200
	Suction pipe alum d63	43843001
	Suct pipe bend alum d63	43843050
	Swivel steel d63	43843100
	Control S for NE 22-76	43220001
	Control S for NE 22-76, wo/control box	43220026
	Control S for NE86-96, wo/control box	43222008

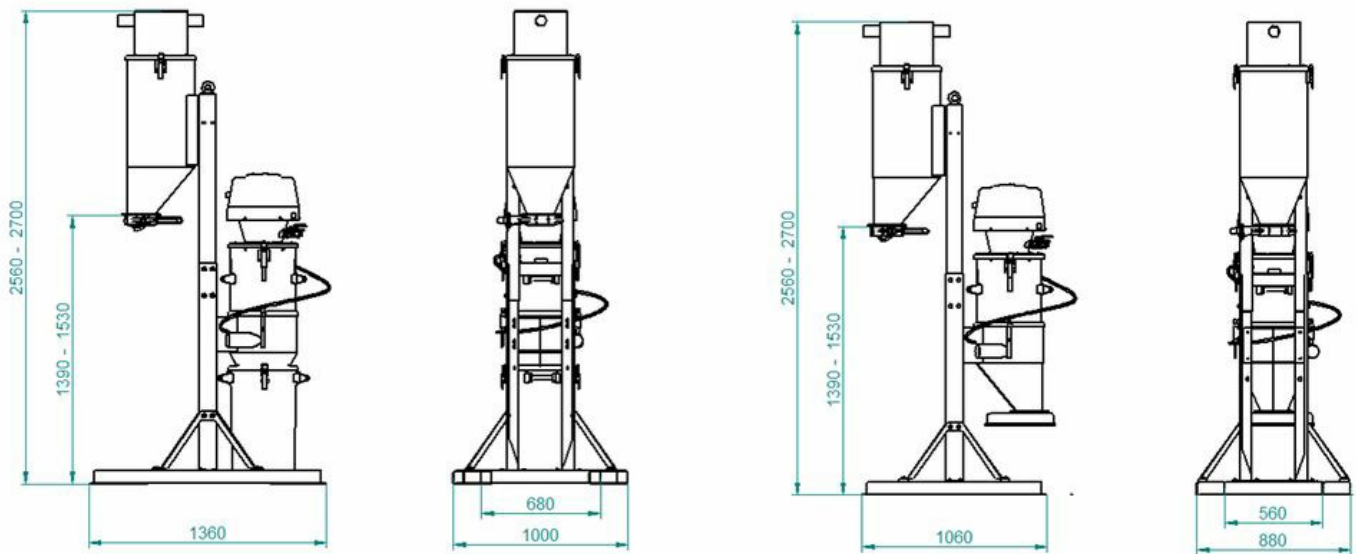

The height of your configuration is depending on which modules you choose

Ejector/Hose dimension	ø51mm	ø63mm	ø76mm
NE52	2	N/A	N/A
NE64	2	2,4	N/A
NE74	2,3	2,7	N/A
NE76	1,7	2,7	3,6
NE96	2,6	3,6	4,9

Capacity (tonne/hour) with Blasting media 2,4kg/liter and 20m hose

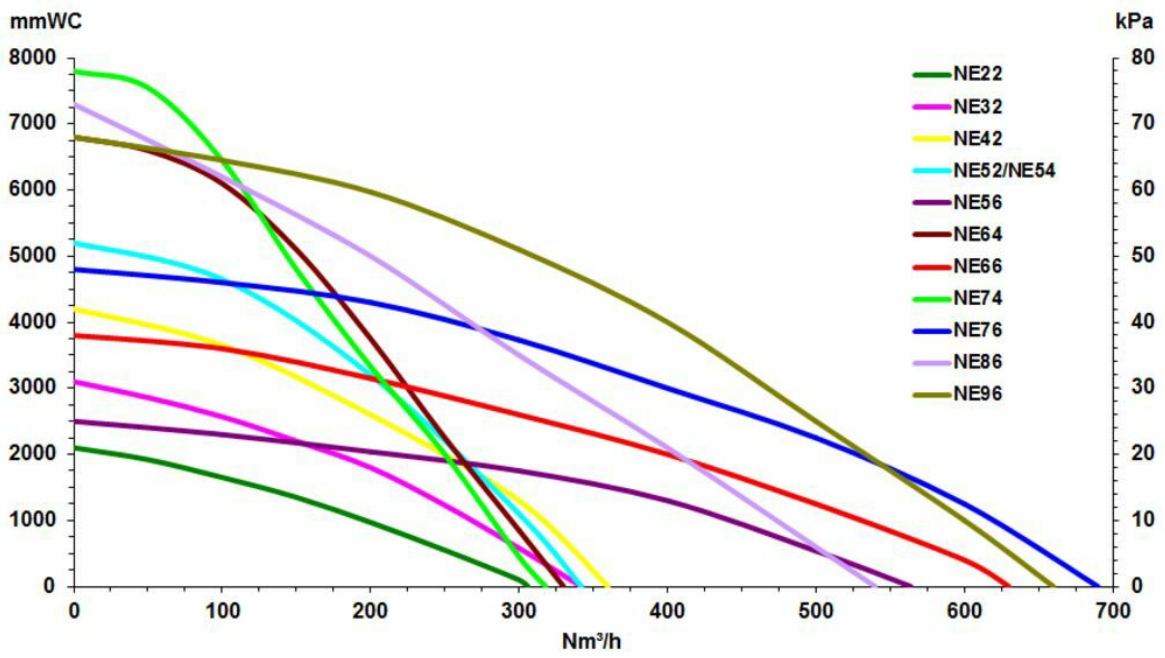

Air Powered ejectors All performance data are based on 7 bar supply pressure