

471A konfigurierbar

En kraftig støvopsamler, højt vakuum for udsugning over lange afstande

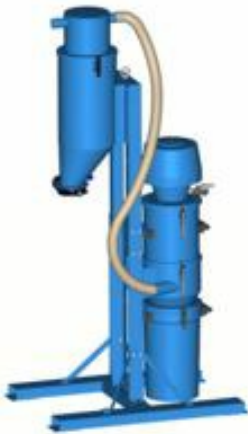

471A konfigurerbar

- ✓ Robust og selvrensende filter
- ✓ Meget kraftfuld og driftssikker ejektor som leverer vakuum
- ✓ Velegnet til kraftigt og/eller abrasivt materiale
- ✓ Styring med mange forskellige funktioner findes som tilbehør

Nederman forudskiller og vakuum transportsystem forudskiller og tømmer støv og granulat ud under støvsugning og vakuumtransport. Systemet kan håndtere tørre materialer som cement, gødning, grit og sand samt våde materialer. Det opsamlede materiale kan tømmes ud i tanke, containere, big-bags eller til transportbånd osv.

Modulets konfiguration svarer til en 471 A, som er beregnet til der håndeste applikationer, f.eks. håndtering af store mængder slibende og tungt materiale. Enhedens robusthed og strømmen fra den pålidelige ejektor gør enheden yderst velegnet til til mange applikationer hvor mange industrielle støvsugere ikke kan anvendes. For eksempel opsamling af sandblæsningsmateriale i blæsehaller, sand fra støberier osv.

Enheden kan konfigureres til at opfylde dit specifikke behov. Forskellige ejektorer kan anvendes afhængig af behov og tilgængeligheden af trykluft. Ejektoren placeres på en stationær silo med filter. Nederman har et bredt udvalg af tømmeventiler, som kan monteres på siloen for nem tømning af det opsamlede materiale. Hvis der håndteres store mængder materiale og for at gøre materialehåndteringen mere effektiv, anbefaler Nederman at der bruges en forudskiller før vakuumentheden. 471A er en komplet enhed inklusiv forudskiller.

For at konfigurere dit 471 A skal du udvælge følgende:

1. Vælg ejektor modul afhængig af krævet vakuum og luftmængde.
2. Vælg filtermodul afhængig af filter kapacitet.
3. Vælg silomodul afhængig af bortskaffelsesmetode.
4. Vælg bortskaffelsesmetode, container eller tømmeventil med plastikpose.
5. Vælg grov forudskiller.
6. Vælg silo.
7. Vælg tømmeventil.
8. Vælg ramme.
9. Vælg slange for tilslutning mellem støvsuger og forudskiller.
10. Vælg rengøringsudstyr.

Vælg hvordan du styrer din butterflyventil:

1. Elektrisk styret
 - du har brug for en namur ventil, magnetventil tilpasset den ejektor størrelse du vælger og en styreboks.
2. Trykluftstyret
 - du har brug for en namur ventil.

Slange til lufttilførsel til namur ventil leveres ikke af Nederman.

Sørg for at alle krav til modulet er opfyldt.



471A konfigurierbar

Cerifikat	CE
Metode for filterrensning	Trykluft

Modeller

	Item number	Trykluftbehov	Maks. luftmængde (m ³ /h)	[ItemMaxVaccum]	Vægt (kg)	Type af filter	Antal filter
	43051004	7 bar and 3,0 Nm ³ /min	342 Nm ³ /h	-52	13		
	43051005	7 bar and 4,3 Nm ³ /min		-68	13		
	43051006	7 bar and 5,3 Nm ³ /min		-78	13		
	43160101				22	Stavfilter	36
	43420026				12		
	43420027				12		
	43640001				3		
	43640003 ^[1]				3		
	43751039 ^[2]				55		
	43751040 ^[3]				50		
	43413026				24		
	43332001						
	43334001						

Modeller

	Item number	Trykluftbehov	Maks. luftmængde (m ³ /h)	[ItemMaxVaccum]	Vægt (kg)	Type af filter	Antal filter
	43550002 ^[4]				15		
	43550005 ^[5]				15		

^[1] Recommended with 43630100













^[2] Fits blastpots up to 680mm width. Max height 2,3m.

^[3] Fits blastpots up to 560mm width. Max height 2,3m.













^[4] Suitable for suction hose PU12 Ø51mm with coupler 40377028

^[5] Flap valve 43885001 can be used on the inlet













Tilbehør

	Accessory	Item number
	Tømmeventil, manuel	43630001
	Manuel butterflyventil sæt, MFC	43630400
	Klemmeventil DN65	43632001
	Klemmeventil DN80	43632100
	Klemmeventil DN100	43632200
	Tømmeventil med kontravægt	43630200
	Tømmeventil, pneumatisk	43630100
	Tømmeventil Linatex ø100 sæt med silofalnge	43630300
	Kontrolsystem for ejektorer	43220034
	BLI EX	40375269
	Plastikpose S50 - 25 stk. 630x800	43650104
	Samlemuffe 65	40377028
	Samlemuffe Ø 76 mm	40130990













Tilbehør

	Accessory	Item number
	Samlemuffe d75-89/d53-63mm	43884464
	Samlemuffe d65-75	43884463
	Slange PU12-51 L=10m	43832600
	Slange PU12-51 L=5m	43832500
	Slange PU12-51 L=20m	43832300
	Slange PU12-51 L=7,5m med kobling	43832102
	Slange PU12-51 L=10m med kobling	43832200
	Slange PU12-63 L=5m	43833200
	Slange PU12-63 L=10m	43833001
	Slange PU12-63 L=20m	43833100
	Rengøringssæt komplet d51/500	42932100
	Rengøringssæt komplet d51/400	42932800
	Rengøringssæt komplet d51/400	42932300

Tilbehør

	Accessory	Item number
	Gulvmundstykke d51/500	43840150
	Gulvmundstykke d51/400/65	43840250
	Børste gulvmundstykke d51/400	43840550
	Håndmundstykke, hård børste ø51	43860001
	Tandet mundstykke ø51	43861001
	Konisk mundstykke ø51	43862001
	Vinklet støvsugerør d51 antistatisk	43842150
	Støvsugerør d51 PEHD-el 1m	43842001
	Bulkmundstykke d51 m/håndtag	43850150
	Bulkmundstykke d51	43850001
	Skrabemundstykke ø51 l=1000	43851150
	Skrabemundstykke ø51 l=500	43851050
	Spån mundstykke Ø 50 mm	40150030

Tilbehør

	Accessory	Item number
	Gulvmundstykke d63/500	43840400
	Bulkmundstykke d63	43850050
	Falskluftmundstykke ø63, luge	43850051
	Bulkmundstykke d63 m/håndtag	43850200
	Skrabemundstykke ø63 L = 1000	43851200
	Støvsugerør aluminium d63	43843001
	Vinklet støvsugerør aluminium d63	43843050
	Drejeled stål d63	43843100
	Hose PU12-76 L=2,5m	43834500
	Styring S for NE 22-76	43220001
	Styring S for NE 22-76, uden kontrolboks	43220026
	Styring S for NE86-96, uden kontrolboks	43222008

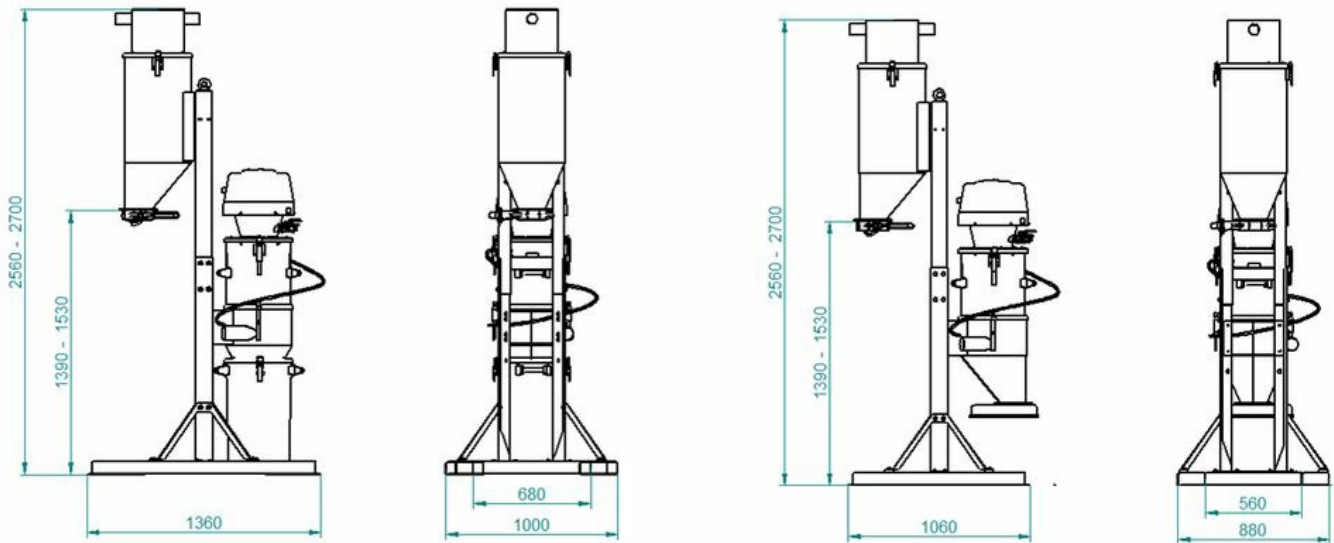

The height of your configuration is depending on which modules you choose

Ejector/Hose dimension	ø51mm	ø63mm	ø76mm
NE52	2	N/A	N/A
NE64	2	2,4	N/A
NE74	2,3	2,7	N/A
NE76	1,7	2,7	3,6
NE96	2,6	3,6	4,9

Capacity (tonne/hour) with Blasting media 2,4kg/liter and 20m hose

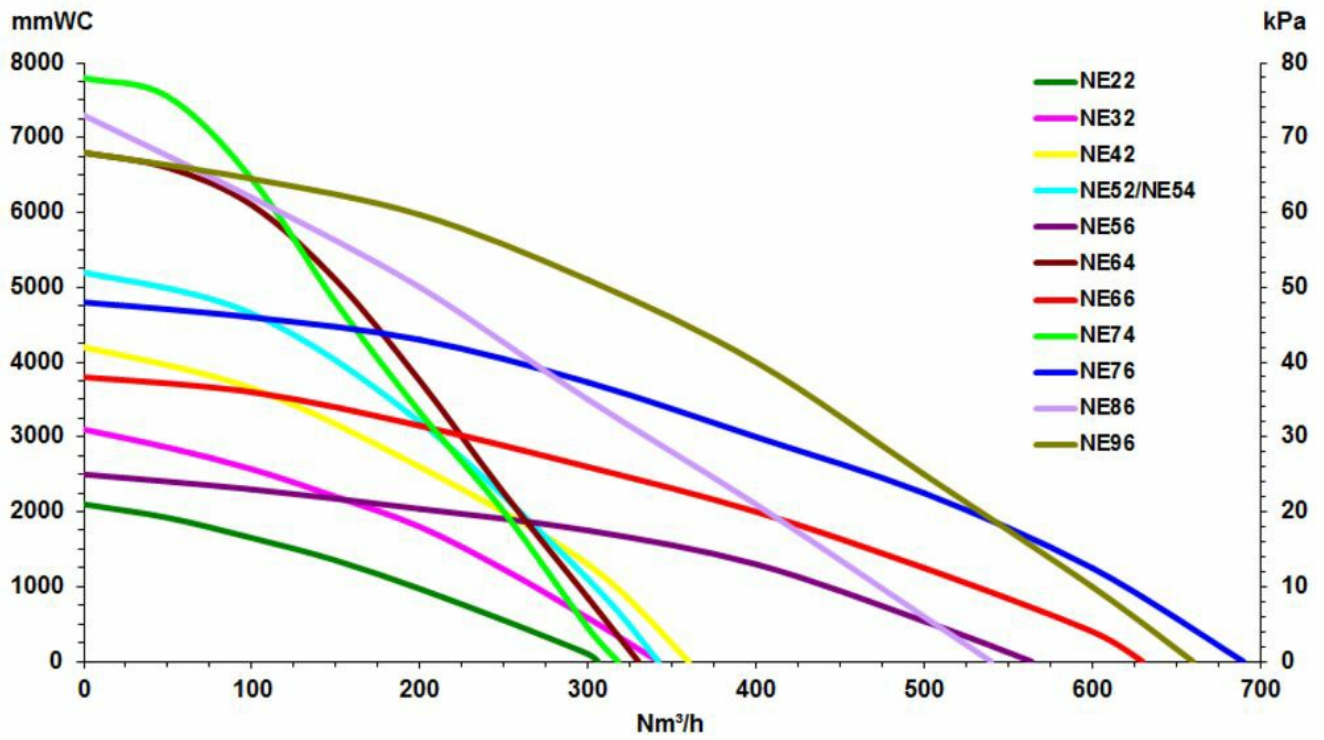

Air Powered ejectors All performance data are based on 7 bar supply pressure