

710A, konfigurierbar

Leistungsstarker Industriesauger ideal für höchste Leistung auch über lange horizontale und vertikale Distanzen, konfigurierbar



710A, konfigurierbar

- ✓ Langlebiger, selbstreinigender Filter
- ✓ Sehr leistungsstarker und verlässlicher Druckluft-Vakuumerzeuger
- ✓ Geeignet für schweres oder abrasives Material
- ✓ Steuerung mit vielfältigen Funktionen als Zubehör erhältlich

Nederman Vorabscheider und Vakuumtransportsystem trennt und scheidet Staub und Granulate ab während der Absaugung oder dem Transport.

Das System trockene Materialien wie Zement, Düngemittel, Sand als auch Flüssigkeiten verarbeiten. Abgeschiedenes Material kann in Behälter, BigBags oder auf Fördersysteme weitergegeben werden.

Die Konfiguration der Module ist ähnlich zum 710A, welche für anspruchsvolle Anwendungen ausgelegt sind (abrasive oder schwere Stoffe). Die Robustheit und Leistung der Einheit macht sie ideal für Industrieranwendungen an denen Staubsauger scheitern, beispielsweise Recycling von Strahlgut sowohl beim Strahlen als auch in der Gießerei-Industrie.

Ihre Einheit kann ihrer Anwendungentsprechend konfiguriert werden. Verschiedene Saugköpfe entsprechend Ihrer Anforderung als auch entsprechend Ihrer Druckluftverfügbarkeit können gewählt werden. Der Ejektor-Saugkopf kann Stationär mit Silo und Filter geliefert werden.

Nederman hat eine Vielzahl von Austragsventilen für die Schüttgüter. Bei Verwendung mit großen Mengen an Schüttgut empfehlen wir einen Vorabscheider für dem Industriesauger. Der 710A ist eine komplette Einheit mit Vorabscheider.

Zur Konfiguration Ihres 710A wählen Sie zunächst Anhang der Checkliste verfügbares Zubehör gekennzeichnet mit mfc (module for configuration/Modul für Konfiguration) in der Artikelbezeichnung.

Filterstufe

1. Wähle Ejektor-Saugkopf entsprechend Saugbedarf und verfügbarer Druckluft.
2. Wähle Filtermodul entsprechend der Belastung
3. Wähle Silomodul entsprechend Austragswunsch
4. Wähle Austragsvariante, Behälter oder Ventil mit BigBag-Halter

Vorabscheidermodul

1. Wähle Vorabscheider Typ
2. Wähle Vorabscheider-Silo
3. Wähle Austragsventil
4. Wähle Aufständering
5. Wähle Saugschlauch zwischen Vorabscheider und Vakuumgerät
6. Wähle Schlauchverbinder, abhängig von Vorabscheider und Schlauch
7. Wähle Saugschlaucharmatur

Wählen Sie wie das Austragsventil gesteuert wird

1. Elektrisch

- Wir empfehlen ein NAMUR Ventil oder Magnetventil passend zur gewählten Ejektorkopfgröße und eine geeignete Steuerung.

2. Pneumatisch

- Sie benötigen ein NAMUR-Ventil.

Verbindungsschlauch zum NAMUR-Ventil ist nicht im Lieferumfang enthalten...

710A, konfigurierbar

Zertifikat	CE
Applikation	Granulat, Strahlgut/Sande, Späne, Stäube

This content is protected under copyright law, furnished for informational use only, and subject to change without notice. © Nederman Holding AB













2026-06-11

3/13

Nederman

710A, konfigurierbar

Modelle

	Item number	Druckluftbedarf	Max. Volumenstrom (m³/h)	Geräuschpegel (dB(A))	Max. Vakuum	Gewicht (kg)	Filtertyp	Anzahl der Filter	Durchmesser (mm)	[ItemLength]
	43051000 ^[1]	4,3 Nm³/min @ 7 bar	330 Nm³/h	77	-68	18				
	43750001									
	43441001									
	43561001									
	43661008									
	43051001 ^[1]	5,3 Nm³/min @ 7 bar	318 Nm³/h	75	-78	18				
	43051002 ^[2]	5,4 Nm³/min @ 7 bar	690 Nm³/h	78	-48	18				
	43051003 ^[2]	8,6 Nm³/min @ 7 bar	660 Nm³/h	78	-68	18				
	43164101 ^[3]					55	Schlauchfilter	70		
	43461007									
	43752001									
	43756001 ^[4]									
	43756100 ^[4]									

This content is protected under copyright law, furnished for informational use only, and subject to change without notice. © Nederman Holding AB

2026-06-11



4/13

Nederman

710A, konfigurierbar

Modelle

Item	Max. Volumenstrom	Geräuschpegel	Max.	Gewicht	Anzahl der	Durchmesser
------	-------------------	---------------	------	---------	------------	-------------

	number	Druckluftbedarf	(m ³ /h)	(dB(A))	Vakuum	(kg)	Filtertyp	Filter	(mm)	[ItemLength]
	43757001 ^[5]									
	43834100				61				76	5

^[1] Empfohlen mit Filtermodul 43162101

^[2] Empfohlen mit Filtermodul 43164101

^[3] 5,25 m² Filterfläche

^[4] Each configuration needs the quantity of three legs, so to get a complete product you need to order three pieces of chosen number

^[5] To be used with 43756100, order three pieces

This content is protected under copyright law, furnished for informational use only, and subject to change without notice. © Nederman Holding AB



2026-06-11













5/13

Nederman

710A, konfigurierbar

Accessories

	Accessory	Item number
	Auslassventil, manuell (0920200)	43630001
	Quetschventil DN65	43632001

	Accessory	Item number
		
	Manual butterflyvalve kit, MFC	43630400
	Quetschventil DN80	43632100
	Quetschventil DN100	43632200
	Auslassventil mit Gegengewicht	43630200
	Auslassventil, pneumatisch	43630100
	Auslassventil Linatex d100 Set mit Silo-Flansch	43630300
	Beutelhalter für 43630200 or 43631001	43640001
	Beutelhalter für 43630100	43640003
	Beutelhalter Bigbag	43640201
	Bagholder for big bag, MFC	43640217
	Kontroll-System für NE 22-76	43220026

This content is protected under copyright law, furnished for informational use only, and subject to change without notice. © Nederman Holding AB



2026-06-11











6/13

Nederman

710A, konfigurierbar

Accessories

	Accessory	Item number
	Schaltssystem f. Ejektor-Sauger	43222008
	Kontroll-System für NE 22-76	43220001

	Accessory	Item number
	Kontroll-System für NE86-96	43222001
	Montageplatte für Schaltsystem	43690001
	Control system for Ejectors	43220034
	Schlauch PU12-51 L=10m	43832600
	Schlauch PU12-51 L=5m	43832500
	PU Schlauch d51 20m	43832300
	7,5m PU-Saugschlauch d=51	43832102
	10m PU-Saugschlauch d=51 mit Kupplungen (1025221)	43832200
	Schlauch PU12-63 L=5m	43833200
	PU Schlauch d63 10m	43833001
	PU Schlauch d63 20m	43833100

This content is protected under copyright law, furnished for informational use only, and subject to change without notice. © Nederman Holding AB



2026-06-11











7/13

Nederman

710A, konfigurierbar

Accessories

	Accessory	Item number
	PU Schlauch d76 10m	43834200
	20m PU-Saugschlauch d=76	43834300
	Bodenreinigungsausstattung d=51/B=500	42932100

	Accessory	Item number
	Bodenreinigungsausstattung d51/400	42932800
	Bodenreinigungsausstattung d51/400	42932300
	Bodensaugdüse d=51/B=500	43840150
	Bodensaugdüse d=51/B=400/65	43840250
	Bodensaugdüse mit Bürste	43840550
	Handsaugdüse rund mit Bürste	43860001
	Handsaugdüse, flach d=51 (1014230)	43861001
	Handsaugdüse, konisch (1014261)	43862001
	Bogen für Saugrohr d=51	43842150
	Saugrohr d=51/antistatisch	43842001

This content is protected under copyright law, furnished for informational use only, and subject to change without notice. © Nederman Holding AB



2026-06-11











8/13

Nederman

710A, konfigurierbar

Accessories

	Accessory	Item number
	Nebenluftsaugrohr d=51 mit Griff	43850150
	Nebenluftsaugrohr d=51	43850001
	Flachdüse d=51/L=1000	43851150

	Accessory	Item number
	Flachdüse d=51/L=500	43851050
	Drehspandüse Ø 50	40150030
	Bodensaugdüse d=63/B=500	43840400
	Nebenluftsaugrohr d=63	43850050
	Nebenluftsaugrohr d=63 mit Haken	43850051
	Nebenluftsaugrohr d=63 mit Griff	43850200
	Flachdüse d=63/L=1000	43851200
	Rohrbogen mit Griff d=63	43843050
	Drehgelenk/Edelstahl d=63	43843100
	Saugrohr Aluminium d=63	43843001

This content is protected under copyright law, furnished for informational use only, and subject to change without notice. © Nederman Holding AB



2026-06-11











9/13

Nederman

710A, konfigurierbar

Accessories

	Accessory	Item number
	Flachdüse d=63/L=500	43851100
	Nebenluftsaugrohr d=76 (1014103)	43850100
	Nebenluftsaugrohr d=76 mit Griff	43850250
	Flachdüse d=76/L1000	43851250

	Accessory	Item number
		
	Reduzierstück d=76-63	43880350
	Reduzierstück d=76-51(1016022)	43880300
	Reduzierstück d=63-51	43880250
	Schlauchverbinder d=63	43880100
	Schlauchverbinder d=50	43880050
	ATEX-zugelassener Füllstandsanzeiger für die sichere Überwachung in gefährlichen Umgebungen mit ausführlicher Bedienungsanleitung.	40375269
	Joint sleeve 75-89/53-63mm	43884464
	Joint sleeve 75 (d65-75mm)	43884463
	NOTE! Leadtime may change. Pipe connection d98-114/d70-88	43884462

This content is protected under copyright law, furnished for informational use only, and subject to change without notice. © Nederman Holding AB



2026-06-11

10/13

Nederman

710A, konfigurierbar

Accessories

	Accessory	Item number
	Einlassrohr d=76, konisch	43880150
	Bodensaugdüse d=63/B=600	43840450

This content is protected under copyright law, furnished for informational use only, and subject to change without notice. © Nederman Holding AB

2026-06-11

11/13

Nederman

710A, konfigurierbar

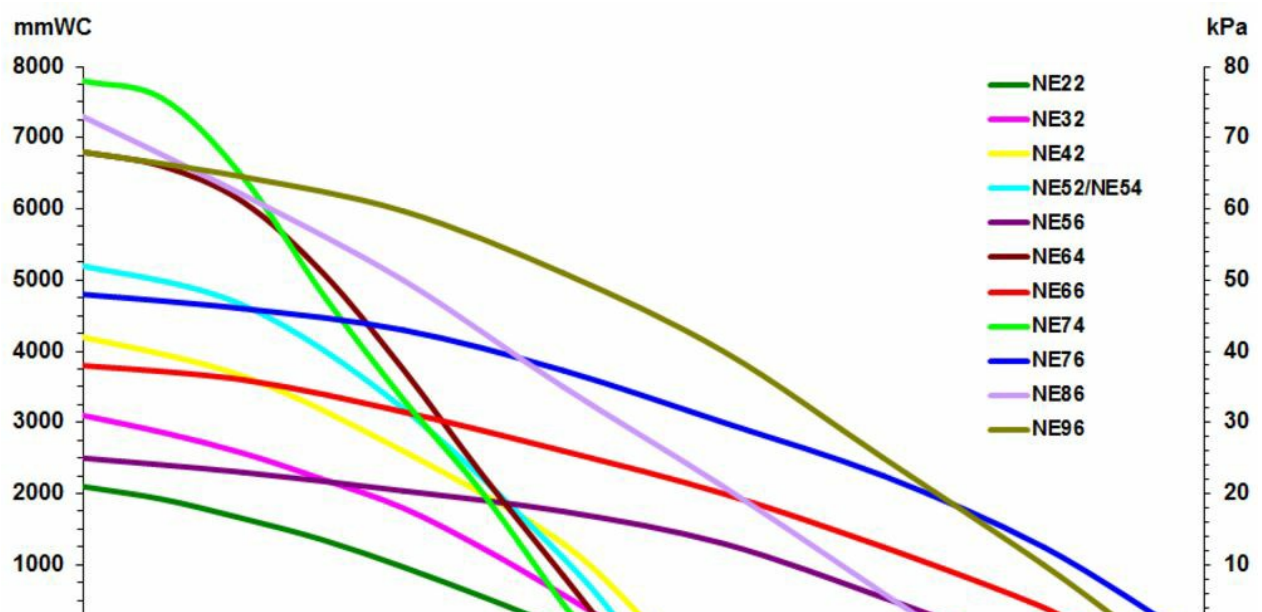

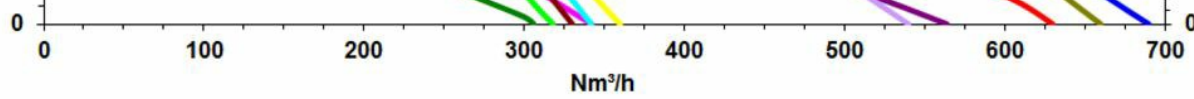

Druckluftbetriebene Ejektoren Alle Leistungsdaten sind bezogen auf 7 bar am Saugkopf

Ejector/Hose dimension	ø51mm	ø63mm	ø76mm
NE64	2	2,4	N/A
NE74	2,3	2,7	N/A
NE76	1,7	2,7	3,6
NE96	2,6	3,6	4,9

Kapazität (Tonnen/Stunde) mit Strahlgut 2,4kg/liter und 20m Schlauch

This content is protected under copyright law, furnished for informational use only, and subject to change without notice. © Nederman Holding AB

2026-06-11

12/13

Nederman

710A, konfigurierbar

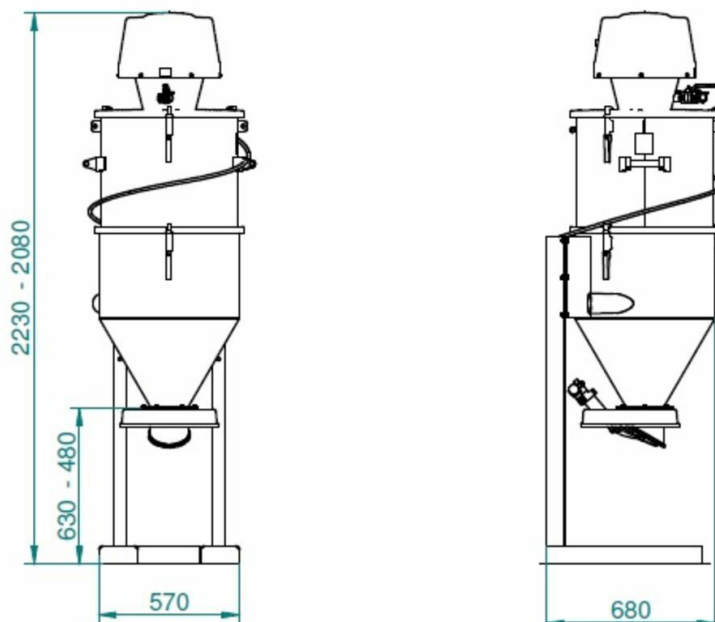

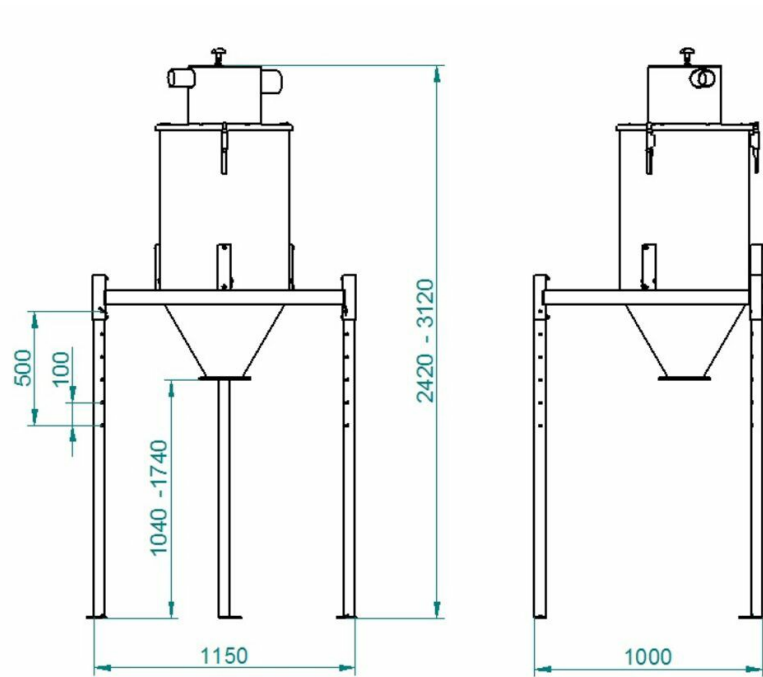

Abmessungen - Vorabscheidereinheit

This content is protected under copyright law, furnished for informational use only, and subject to change without notice. © Nederman Holding AB