

Product leaflet

710A, Ayarlanabilir.

Güçlü bir toz toplayıcı, uzun yatay ve dikey mesafeler üzerinde emiş için mükemmel yüksek vakum



710A, Ayarlanabilir.

- ✓ Dayanıklı ve etkili kendinden temizleme özellikli filtre
- ✓ Vakum üretici olarak çok güçlü ve güvenilir ejektör
- ✓ Ağır ve/veya aşındırıcı malzemeler için uygun
- ✓ Birçok farklı fonksiyona sahip kontrol sistemi aksesuar olarak mevcuttur.

Nederman Ön Ayırma ve Vakum Taşıma Sistemleri vakumlama ve vakumlu taşıma esnasında toz ve granül maddeleri önceden ayırır ve boşaltır.

Çimento, gübreler, çakıl, kum gibi kuru maddelerin yanı sıra ıslak maddeleri de işleyebilen bir sistemi. Toplanan maddeler tanklar, konteynerler, büyük torbalar, taşıyıcı bantlar, yürüyen merdivenler vb. içerisine boşaltılabilir.

Modüllerin konfigürasyonu, en zorlu uygulamaları amaçlayan 710A'ya benzer olacaktır, örneğin çok aşındırıcı ve ağır malzeme işlenmesi gibi. Ünitenin dayanıklılığı ve güvenilir ejektörden gelen güç üniteyi birçok endüstriyel vakumlu temizleyicinin kullanılmadığı uygulamalar için çok uygun hale getirir. Örneğin kumlama atölyelerinde kumlama malzemesi toplamak, dökümhanelerde kum geri kazanımı vb.

Üniteniz özel taleplerinizi karşılayacak şekilde yapılandırılabilir. Talep halinde ancak sıkıştırılmış havanın mevcudiyetine bağlı olarak farklı ejektörler kullanılabilir. Ejektör filtreli sabit bir silo üzerine yerleştirilebilir.

Nederman, toplanan malzemelerin kolayca boşaltılması için siloya takılabilen farklı boşaltma vanaları yelpazesine sahiptir. Daha büyük miktarda malzemelerin kullanılması durumunda ve malzeme taşınmasını daha etkin hale getirmek amacıyla Nederman, vakum ünitesinden önce bir ön ayırıcı kullanılmasını önermektedir. 710A, bir ön ayırıcı içeren komple bir ünedir.

710A'nızı yapılandırmak için sadece bu belgede listelenen modülleri ve başlıkta bulunan mfc (yapılandırma için modül) seçebilirsiniz. Filtre tarafı

1. Gerekli vakum ve hava akışına bağlı olarak ejektör modülünü seçin.
2. Filtre kapasitesine bağlı olarak filtre modülünü seçin.
3. Silo modülünü seçin.
4. İmha seçeneğini, torba tutucuyu veya boşaltma vanasını seçin.
5. Çerçeveyi seçin.

Ayırıcı tarafı

1. İri tane ayırıcıyı seçin.
2. Silo modülünü seçin.
3. Boşaltma vanasını seçin.
4. Çerçeveyi seçin.
5. Vakumlu temizleyici ile ayırıcı arasındaki bağlantı için hortum seçin.
6. İri tane ayırıcı ile hortuma bağlı olarak manşonlu bağlantıyı seçin.
7. Temizleme donanımını seçin.

Kelebek vanayı nasıl kontrol edeceğinizi seçin:

1. Elektrik kontrollü - Seçtiğiniz ejektör boyutu ve uygun bir kontrol kutusu için önerilen bir namur vanaya, selenoid vanaya ihtiyacınız var.

2. Hava kontrollü - Bir namur vanaya ihtiyacınız var.

Namur vanasına hava beslemesi için hortum Nederman tarafından sağlanmamaktadır...

710A, Ayarlanabilir.













Sertifikalar	CE
[ProductApplication]	[granulate], [grit], [swarf], [dust]

This content is protected under copyright law, furnished for informational use only, and subject to change without notice. © Nederman Holding AB

2026-06-11

3/13

Models

	Item number	[ItemCompressedAirRequirement]	[ItemMaxAirFlow]	[ItemMaxVaccum]	Ağırlık (kg)	Filtre türü	Filtre adedi	çap (mm)	[ItemLength]
	43051000 ^[1]	4,3 Nm ³ /min @ 7 bar	330 Nm ³ /h	-68	18				
	43750001								
	43441001								
	43561001								
	43661008								
	43051001 ^[1]	5,3 Nm ³ /min @ 7 bar	318 Nm ³ /h	-78	18				
	43051002 ^[2]	5,4 Nm ³ /min @ 7 bar	690 Nm ³ /h	-48	18				
	43051003 ^[2]	8,6 Nm ³ /min @ 7 bar	660 Nm ³ /h	-68	18				
	43164101				55	[NCF]	70		
	43461007								
	43752001								
	43756001 ^[3]								
	43756100 ^[3]								

This content is protected under copyright law, furnished for informational use only, and subject to change without notice. © Nederman Holding AB



2026-06-11

4/13

Nederman

710A, Ayarlanabilir.

Models

	Item number	[ItemCompressedAirRequirement]	[ItemMaxAirFlow]	[ItemMaxVaccum]	Ağırlık (kg)	Filtre türü	Filtre adedi	çap (mm)	[ItemLength]
	43757001 ^[4]								
	43834100			61				76	5

^[1] Filtre modülü 43162101 ile tavsiye edilir.

^[2] Filtre modülü 43164101 ile tavsiye edilir.

^[3] Her bir konfigürasyon üç ayak miktarında ihtiyaç duyar, bu yüzden komple PorChannel elde etmek için Hortum sayısının üç parçasını sipariş etmeniz gerekmektedir.

^[4] 43756100 ile kullanılmalıdır, üç parçayı sipariş ediniz.

This content is protected under copyright law, furnished for informational use only, and subject to change without notice. © Nederman Holding AB

2026-06-11

5/13













Nederman

710A, Ayarlanabilir.

Accessories

Accessory

Item number

	Accessory	Item number
	Boşaltma vanası manuel	43630001
	Esnek vana DN65	43632001
	manuel kelebek vana kit, MFC	43630400
	Esnek vana DN80	43632100
	Esnek vana DN100	43632200
	disk vanası denge ağırlıklı	43630200
	Boşaltma vanası Pnömatik	43630100
	Boşaltma vanası Linatex d100 set w/	43630300
	Torba tutucu 0920220/230 için	43640001
	Torba tutucu 0920210 için	43640003
	Torba tutucu büyük torba için	43640201
	Büyük torba için torba tutucu, MFC	43640217
	NE 22-76 için kontrol S, kontrol kutusuz	43220026

This content is protected under copyright law, furnished for informational use only, and subject to change without notice. © Nederman Holding AB

2026-06-11













6/13

Nederman

710A, Ayarlanabilir.

Accessories

	Accessory	Item number
	NE86-96 için kontrol S, kontrol kutusuz	43220008

	Accessory	Item number
		
	NE 22-76 için kontrol S	43220001
	NE 86 ejektörü için elektriksel kontrol sistemi. (Emiş süresi: 0 - 5 dakika, Tahliye süresi: 0 - 15 saniye)	43222001
	Montaj plakası 0802010+0801020 için	43690001
	Çıkarıcılar için kontrol sistemi	43220034
	Hortum PU12-51 U=10m	43832600
	Hortum PU12-51 U=5m	43832500
	Hortum PU12-51 U=20m	43832300
	Hortum PU12-51 U=7,5m w. Kaplin	43832102
	Hortum PU12-51 U=10m kavramalara sahip	43832200
	Hortum PU12-63 U=5m	43833200
	Hortum PU12-63 U=10m	43833001
	Hortum PU12-63 U=20m	43833100

This content is protected under copyright law, furnished for informational use only, and subject to change without notice. © Nederman Holding AB

2026-06-11













7/13

Nederman

710A, Ayarlanabilir.

Accessories

	Accessory	Item number
	Hortum PU12-76 U=10m	43834200

	Accessory	Item number
	Hortum PU12-76 U=20m	43834300
	Emiş donanımı komple d51/500	42932100
	Emiş donanımı komple d51/400	42932800
	Emiş donanımı komple d51/400	42932300
	Zemin emiş başlığı d51/500	43840150
	Zemin emiş başlığı d51/400/65	43840250
	fırça emiş başlığı d51/400	43840550
	el emiş h sert fırça d51	43860001
	el emiş başlığı pp d51	43861001
	konik nozulu d51	43862001
	emiş borusu Dirsek d51 anti statik	43842150
	emiş borusu d51 PEHD-el 1m	43842001

This content is protected under copyright law, furnished for informational use only, and subject to change without notice. © Nederman Holding AB



2026-06-11













8/13

Nederman

710A, Ayarlanabilir.

Accessories

	Accessory	Item number
	Gulper başlığı d51 kollu	43850150
	Gulper başlığı d51	43850001

	Accessory	Item number
		
	Kazıma aleti d51 I1000	43851150
	Kazıma aleti d51 I500	43851050
	nozul Talaş D=50mm	40150030
	Zemin emiş başlığı d63/500	43840400
	Gulper başlığı d63	43850050
	Gulper başlığı d63 kapak	43850051
	Gulper başlığı d63 kollu	43850200
	Kazıma aleti d63 I1000	43851200
	emiş borusu Dirsek Alüminyum d63	43843050
	dönme çelik d63	43843100
	emiş borusu Alüminyum d63	43843001

This content is protected under copyright law, furnished for informational use only, and subject to change without notice. © Nederman Holding AB



2026-06-11













9/13

Nederman

710A, Ayarlanabilir.

Accessories

	Accessory	Item number
	Kazıma aleti d63 I500	43851100
	Gulper başlığı d76	43850100

	Accessory	Item number
		
	Gulper başlığı d76 kolları	43850250
	Kazıma aleti d76 l1000	43851250
	Hortum kırmızı konik d76-63	43880350
	kırmızı konik d76-51	43880300
	Hortum kırmızı konik d63-51	43880250
	Hortum konnektörü d63	43880100
	Hortum konnektörü d50	43880050
	BLI (Kutu seviye göstergesi) EX	40375269
	Manşonlu bağlantı d75-89/d53-63mm	43884464
	Manşonlu bağlantı d65-75	43884463
	Manşonlu bağlantı d98-114/d70-88	43884462

This content is protected under copyright law, furnished for informational use only, and subject to change without notice. © Nederman Holding AB



2026-06-11

10/13

Nederman

710A, Ayarlanabilir.

Accessories

	Accessory	Item number
	Hortum bağlantısı konik d76	43880150
	Zemin emiş başlığı d63/600	43840450

This content is protected under copyright law, furnished for informational use only, and subject to change without notice. © Nederman Holding AB

2026-06-11

11/13

Nederman

710A, Ayarlanabilir.

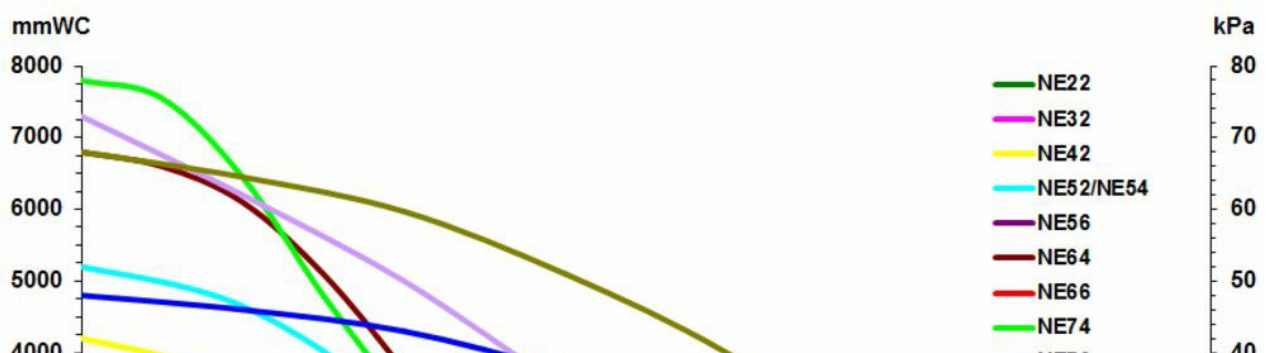

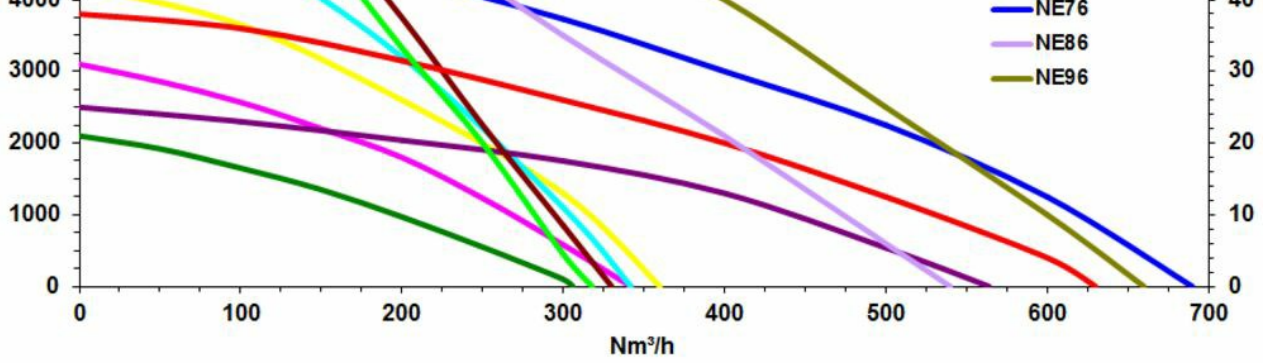

Air Powered ejectors All performance data are based on 7 bar supply pressure

Ejector/Hose dimension	ø51mm	ø63mm	ø76mm
NE64	2	2,4	N/A
NE74	2,3	2,7	N/A
NE76	1,7	2,7	3,6
NE96	2,6	3,6	4,9

Capacity (tonne/hour) with Blasting media 2,4kg/liter and 20m hose

This content is protected under copyright law, furnished for informational use only, and subject to change without notice. © Nederman Holding AB

2026-06-11

12/13

Nederman

710A, Ayarlanabilir.

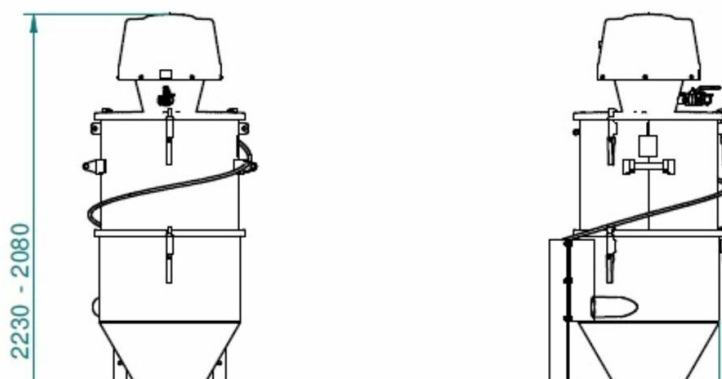

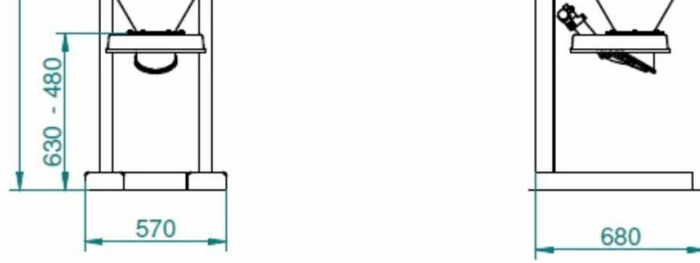

Dimensions - Filter part

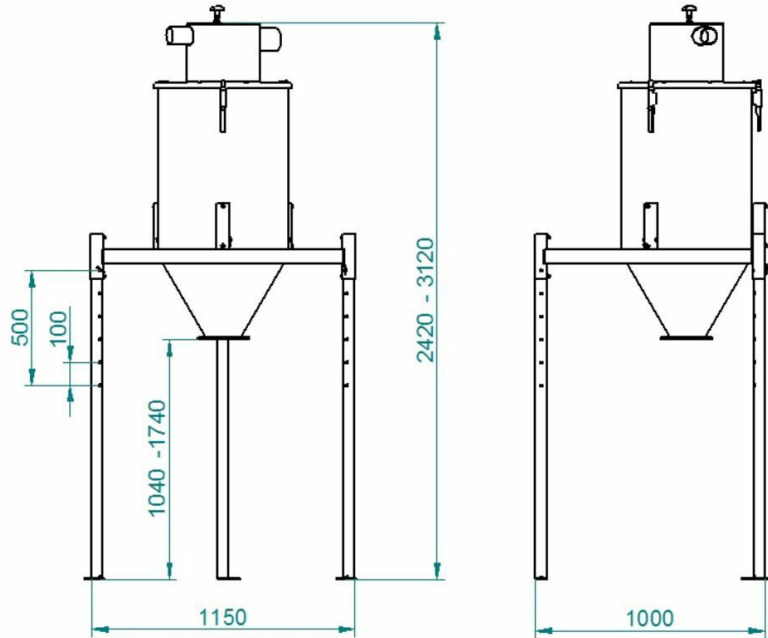

Dimensions pre-separation part