

S-Series Dust Collector

Simple, silent and safe enclosureless dust collector for wood dust applications



S-Series Dust Collector

- ✓ High performance Superbags reduces bag replacement needs down to 3-5 years
- ✓ Energy efficient fans utilize an impeller design that is 20% more efficient than common radial blade fans
- ✓ Silent operation with high performance fans run only 10-15 dB(A) over normal conversation sound level
- ✓ Provide safety and reliability for your workplace and manufactured in compliance with the latest NFPA standards
- ✓ Unique collapsible design with pre-installed fan and SuperBags minimize installation time and effort with 3 step easy and quick installation.













The S-Series is an enclosureless, silent and simple to set up dust collector suitable for wood and sawdust applications (furniture, cabinetry, windows, doors, flooring, particle board, MDF, building materials, marine, and sawmills) and for general dust collection where feasible.

It is designed for indoor installation compliant with NFPA combustible dust regulations. They are available in three sizes: the S-500, S-750 and S-1000 ranging from 1,500 - 5,000 CFM, providing a cost-effective filtration solution for small and medium-sized workshops.

S-Series Dust Collector

[ProductInstallation]	[Indoor]
Material	Galvanized Steel
[ProductSuitableForCombustableDust]	True
Filter cleaning method	[OneWayFilter], [Shaking]
Application	[dust]
Dustbin volume (gal)	42 for Bags (standard); 45 for Barrels (optional); 230 for Dump Bin (optional)
Filter Area (ft²)	10.125 / bag
Capacity (max airflow cfm)	5000
Filter type	[bag]
Filtermaterial	Superbag

Models

	Item no	Power voltage (V)	Frequency (Hz)	No of phases	Number of filter elements	Weight (lbs)	Power (Hp)	Control voltage (V)
	89101005 ^[1]	230	60	1	16	600	5.0 (3.75 Kw)	
	89101006 ^[1]	230/460	60	3	16	600	5.0 (3.75 Kw)	
	89101007 ^[2]	230	60	1	16	900	7.5 (5.5 Kw)	
	89101008 ^[1]	230/460	60	3	24	750	7.5 (5.5 Kw)	
	89101009 ^[3]	230/460	60	3	24	1000	10.0 (7.5 Kw)	
	89101018 ^[4]	N/A	N/A		16	600	n/a	n/a
	89101019 ^[2]	575	60	3	24	750	7.5 (5.5 Kw)	
	89101020 ^[3]	575	60	3	24	1000	10.0 (7.5 Kw)	
	89101024 ^[1]	575	60	3	16	600	5.0 (3.75 Kw)	
	89101028 ^[2]	230/460	60	3	24	750	7.5 (5.5 Kw)	
	89101064 ^[2]	575	60	3	24	750	7.5 (5.5 Kw)	
	89101027 ^[3]	230/460	60	3	24	1000	10.0 (7.5 Kw)	
	89101026 ^[3]	575	60	3	24	1000	10.0 (7.5 Kw)	













^[1] 3000 CFM at 5.0" Wg

^[2] 4500 CFM at 5.0" Wg

^[3] 5000 CFM at 7.0" Wg

^[4] Without fan

Accessories

	Accessory	Item no
	S-Series 230 gal (870 L) Dump Bin (Only for use with S-750 & S-1000)	89101011
	S-Series Plastic Bags - Diameter = 20 in (500 mm) Length = 51 in (1300 mm) - 1 Roll (90 pcs)	89201024
	S-Series Replacement Filter Bag for S-500 (Qty 16 Req'd) & S-750 (Qty 24 Req'd)	89251020
	S-Series Replacement Filter Bag for S-1000 (Qty 24 Req'd)	89251021
	S-Series Shut Off Valve	89101082
	S-Series Regulator Filter Combo	89101083
	S-Series S-500 Manual Shaker	89101071
	S-Series S-500 Mechanical Shaker	89101072
	S-Series S-500 Automatic Shaker - 208-230-460 V	89101073
	S-Series S-500 Automatic Shaker - 575 V	89101074
	S-Series S-750/1000 Manual Shaker	89101075
	S-Series S-750/1000 Mechanical Shaker	89101076
	S-Series S-750/1000 Automatic Shaker - 208-230-460 V	89101077

Accessories

	Accessory	Item no
	S-Series S-750/1000 Automatic Shaker - 575 V	89101078
	S-Series Manual to Mechanical Shaker Upgrade Kit	89101079
	S-Series Manual to Automatic Shaker Upgrade Kit - 230-460 V	89101080
	S-Series Manual to Automatic Shaker Upgrade Kit - 575 V	89101081

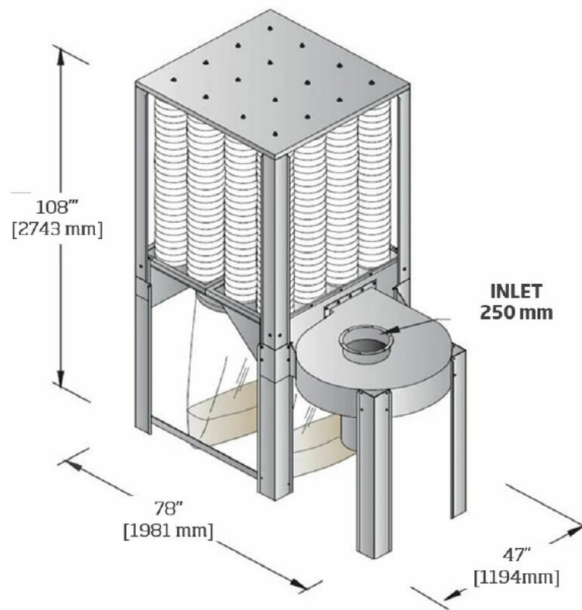

S-500

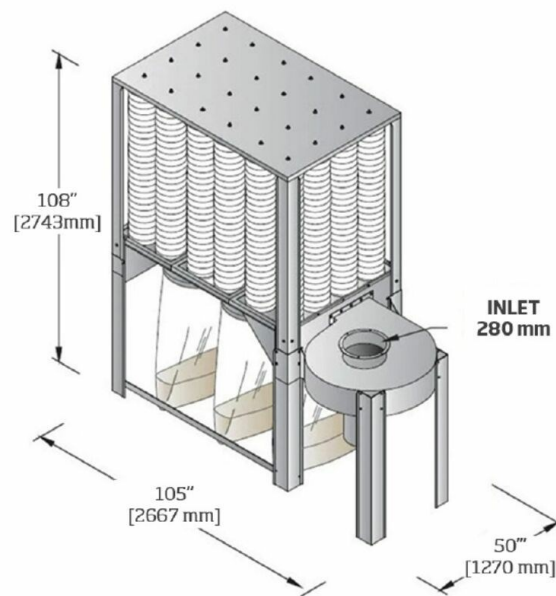

S-750

