

471A configurable

A powerful dust collector, excellent high vacuum for suction over long horizontal and vertical distance

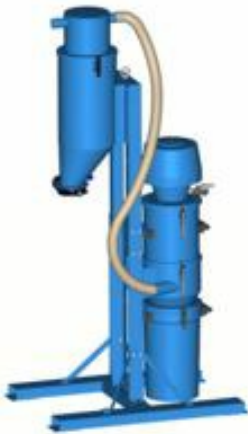

471A configurable

- ✓ Robust and efficient self-cleaning filter
- ✓ Very powerful and reliable ejector as vacuum producer
- ✓ Suitable for heavy and/or abrasive material
- ✓ Control system with many different functions is available as an accessory

Nederman Pre-separation and Vacuum Transportation Systems pre-separate and discharge dust and granulated material during vacuuming and vacuum transport.

A system can handle dry material like cement, fertilizers, grit, sand, as well as wet material. Collected material can be discharged into tanks, containers, big-bags, on to conveyor belts, escalators etc.

The configuration of modules will be similar to 471A which are aimed for the toughest applications, for example handling a lot of abrasive and heavy material. The robustness of the unit and the power from the reliable ejector makes the unit very suitable for many applications where many industrial vacuum cleaners can not be used. For example to collect blasting material in blasting hall, sand recovery in foundries etc.

Your unit can be configured to meet your specific demands. Different ejectors can be used depending on the demand but also the availability of compressed air. The ejector can be placed on a stationary silo with filter.

Nederman has a range of different discharge valves that can be fitted to the silo for easy discharge of the collected material. If handling larger quantities of material and in order to make the material handling more effective Nederman recommends using a pre separator before the vacuum unit. The 471A is a complete unit including a pre separator.

To configure your 471A you may only choose modules listed in this document and with mfc (module for configuration) in title.

1. Select ejectormodule depending on required vacuum and air flow.
2. Select filtermodule depending on filter capacity.
3. Select silomodule depending on disposal option.
4. Select disposal option, container or discharge valve with plastic bag.
5. Select coarse grain separator.
6. Select silo.
7. Select discharge valve.
8. Select frame.
9. Select hose for connection between vacuum cleaner and separator.
10. Select cleaning equipment.

Choose how to control your butterfly valve:

1. Electric controlled
 - You need a namur valve, solenoid valve recommended for the ejector size you choose and a suitable control box.
2. Air controlled
 - You need a namur valve.

Hose for air supply to the namur valve is not supplied by Nederman.

Ensure you meet all requirements for your modules.



471A configurable

Certifications	CE
Méthode de décolmatage	[CompressedAir]

Modèles

	Référence	[ItemCompressedAirRequirement]	[ItemMaxAirFlow]	Volume sonore (dB(A))	[ItemMaxVaccum]	Poids (kg)	Type de filtre	Nombre d'éléments filtrants
	43051004	7 bar and 3,0 Nm ³ /min	342 Nm ³ /h	75,5	-52	13		
	43051005	7 bar and 4,3 Nm ³ /min		77	-68	13		
	43051006	7 bar and 5,3 Nm ³ /min		75	-78	13		
	43160101					22	Filtre à bougie	36
	43420026					12		
	43420027					12		
	43640001					3		
	43640003 ^[1]					3		
	43751039 ^[2]					55		
	43751040 ^[3]					50		
	43413026					24		
	43332001							
	43334001							

Modèles

	Référence	[ItemCompressedAirRequirement]	[ItemMaxAirFlow]	Volume sonore (dB(A))	[ItemMaxVaccum]	Poids (kg)	Type de filtre	Nombre d'éléments filtrants
	43550002 ^[4]					15		
	43550005 ^[5]					15		

^[1] Recommandé avec 43630100













^[2] Fits blastpots up to 680mm width. Max height 2,3m.

^[3] Fits blastpots up to 560mm width. Max height 2,3m.













^[4] Adapté pour tuyau d'aspiration PU12 Ø51 mm avec coupleur 40377028

^[5] Vanne d'isolation 43885001 utilisable sur l'entrée













Accessories

	Accessoire	Référence
	Vanne de décharge manuelle	43630001
	Ensemble vanne papillon, MFC	43630400
	Vanne d'étranglement DN65	43632001
	Vanne d'étranglement DN80	43632100
	Vanne d'étranglement DN100	43632200
	Vanne déch. av. contrepoids	43630200
	Vanne de décharge pneum.	43630100
	Kit Vanne de décharge Linatex d100 av.	43630300
	Control System for Ejectors	43220034
	BLI EX	40375269
	Sac en plastique S50 - 25 pcs 630x800	43650104
	Manchon raccord 65	40377028
	Manchon raccord 76mm, collier de serrage inclus	40130990













Accessories

	Accessoire	Référence
	Manchon raccord d75-89/d53-63 mm	43884464
	Manchon raccord d65-75	43884463
	Tuyau PU12-51 L=10m	43832600
	Tuyau PU12-51 L=5m	43832500
	Tuyau PU12-51 L=20m	43832300
	Tuyau PU12-51 L=7,5 m a. raccords	43832102
	Tuyau PU12-51 L=10 m a. raccords	43832200
	Tuyau PU12-63 L=5m	43833200
	Tuyau PU12-63 L=10m	43833001
	Tuyau PU12-63 L=20m	43833100
	Équip. d'asp. compl. d51/500	42932100
	Équip. d'asp. compl. d51/400	42932800
	Équip. d'asp. compl. d51/400	42932300

Accessories

	Accessoire	Référence
	Tête d'aspiration sol d51/500	43840150
	Tête d'aspiration sol 51/400/65	43840250
	Tête d'aspiration brosse d51/400	43840550
	Tête d'asp. man. rigide brushd51	43860001
	Tête d'aspiration manuelle pp d51	43861001
	Buse conique d51	43862001
	Conduite d'asp. coudé d51 antistat.	43842150
	Conduite d'aspiration d51 PEHD-el 1 m	43842001
	Brosse dure d51 avec poignée	43850150
	Brosse dure d51	43850001
	Outil racleur d51 I1000	43851150
	Outil racleur d51 I500	43851050
	Buse copeaux D=50 mm	40150030

Accessories

	Accessoire	Référence
	Tête d'aspiration sol d63/500	43840400
	Brosse dure d63	43850050
	Brosse dure d63 manche	43850051
	Brosse dure d63 avec poignée	43850200
	Outil racleur d63 I1000	43851200
	Conduite d'aspiration alum. d63	43843001
	Conduite d'asp. coudé alum d63	43843050
	Rotule acier d63	43843100
	Hose PU12-76 L=2,5m	43834500
	Commande S pour NE 22-76	43220001
	Commande Sfor NE 22-76, sans boîtier de commande	43220026
	Commande Sfor NE 86, ss boîtier de commande	43222008

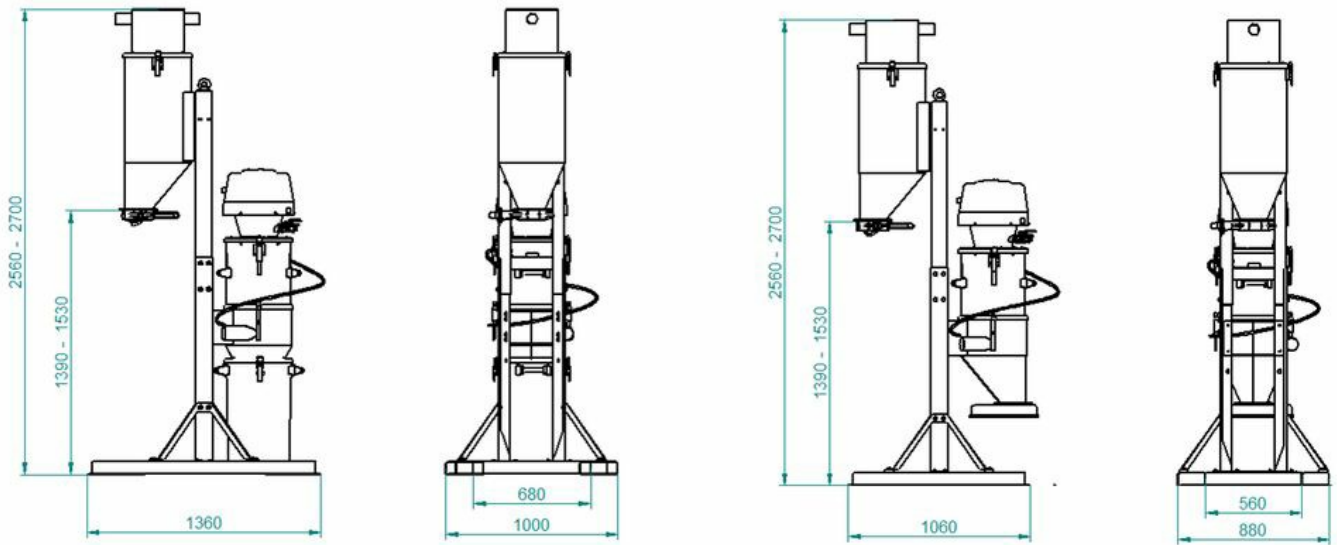

The height of your configuration is depending on which modules you choose

Ejector/Hose dimension	ø51mm	ø63mm	ø76mm
NE52	2	N/A	N/A
NE64	2	2,4	N/A
NE74	2,3	2,7	N/A
NE76	1,7	2,7	3,6
NE96	2,6	3,6	4,9

Capacity (tonne/hour) with Blasting media 2,4kg/liter and 20m hose

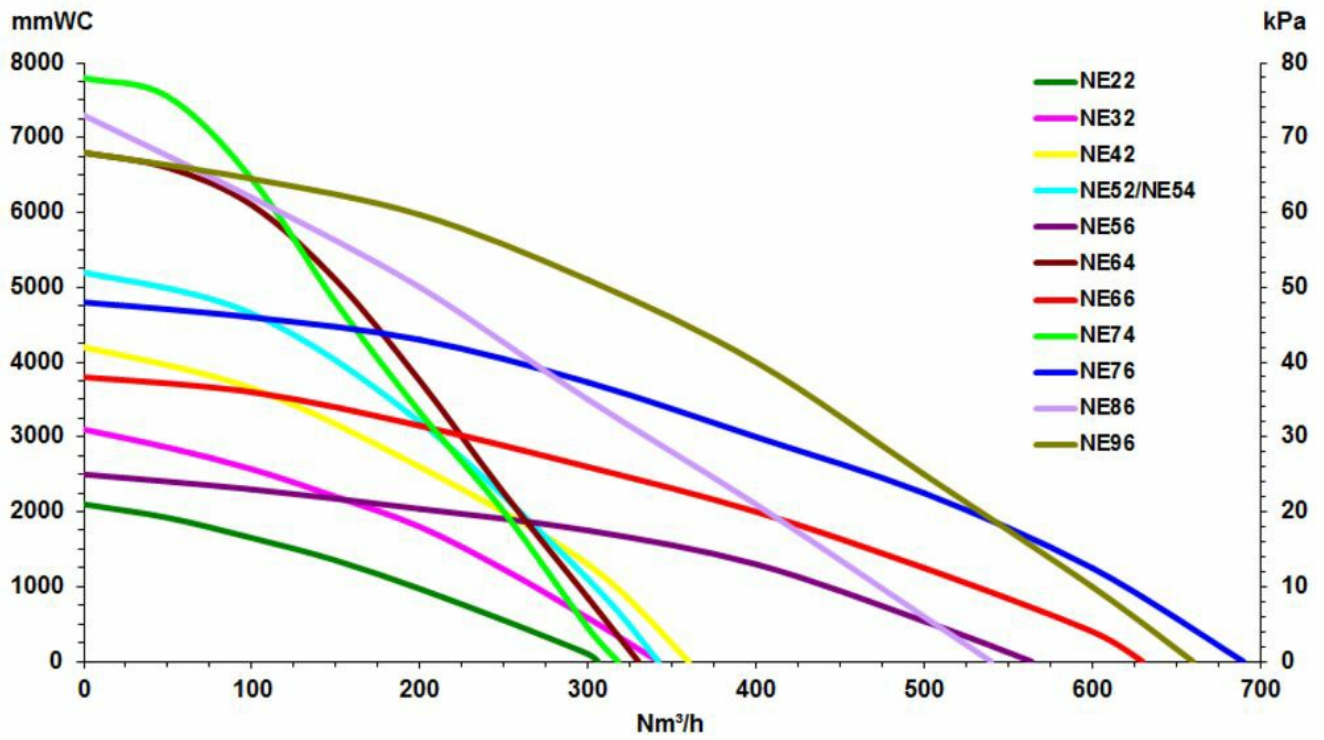

Air Powered ejectors All performance data are based on 7 bar supply pressure