

471A configurable

A powerful dust collector, excellent high vacuum for suction over long horizontal and vertical distance

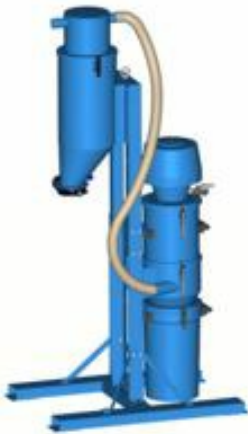

471A configurable

- ✓ Robust and efficient self-cleaning filter
- ✓ Very powerful and reliable ejector as vacuum producer
- ✓ Suitable for heavy and/or abrasive material
- ✓ Control system with many different functions is available as an accessory

Nederman Pre-separation and Vacuum Transportation Systems pre-separate and discharge dust and granulated material during vacuuming and vacuum transport.

A system can handle dry material like cement, fertilizers, grit, sand, as well as wet material. Collected material can be discharged into tanks, containers, big-bags, on to conveyor belts, escalators etc.

The configuration of modules will be similar to 471A which are aimed for the toughest applications, for example handling a lot of abrasive and heavy material. The robustness of the unit and the power from the reliable ejector makes the unit very suitable for many applications where many industrial vacuum cleaners can not be used. For example to collect blasting material in blasting hall, sand recovery in foundries etc.

Your unit can be configured to meet your specific demands. Different ejectors can be used depending on the demand but also the availability of compressed air. The ejector can be placed on a stationary silo with filter.

Nederman has a range of different discharge valves that can be fitted to the silo for easy discharge of the collected material. If handling larger quantities of material and in order to make the material handling more effective Nederman recommends using a pre separator before the vacuum unit. The 471A is a complete unit including a pre separator.

To configure your 471A you may only choose modules listed in this document and with mfc (module for configuration) in title.

1. Select ejectormodule depending on required vacuum and air flow.
2. Select filtermodule depending on filter capacity.
3. Select silomodule depending on disposal option.
4. Select disposal option, container or discharge valve with plastic bag.
5. Select coarse grain separator.
6. Select silo.
7. Select discharge valve.
8. Select frame.
9. Select hose for connection between vacuum cleaner and separator.
10. Select cleaning equipment.

Choose how to control your butterfly valve:

1. Electric controlled
 - You need a namur valve, solenoid valve recommended for the ejector size you choose and a suitable control box.
2. Air controlled
 - You need a namur valve.

Hose for air supply to the namur valve is not supplied by Nederman.

Ensure you meet all requirements for your modules.



471A configurable

Certificeringen	CE
Filter reinigingsmethode	[CompressedAir]

Models

	Item number	Persluchtsbehoefte	[ItemMaxAirFlow]	Max. vacuüm	Gewicht (kg)	Filtertype	Aantal filterelementen
	43051004	7 bar and 3,0 Nm ³ /min	342 Nm ³ /h	-52	13		
	43051005	7 bar and 4,3 Nm ³ /min		-68	13		
	43051006	7 bar and 5,3 Nm ³ /min		-78	13		
	43160101				22	Kaars filter	36
	43420026				12		
	43420027				12		
	43640001				3		
	43640003 ^[1]				3		
	43751039 ^[2]				55		
	43751040 ^[3]				50		
	43413026				24		
	43332001						
	43334001						

Models

	Item number	Persluchtsbehoefte	[ItemMaxAirFlow]	Max. vacuüm	Gewicht (kg)	Filtertype	Aantal filterelementen
	43550002 ^[4]				15		
	43550005 ^[5]				15		

^[1] Recommended with 43630100













^[2] Fits blastpots up to 680mm width. Max height 2,3m.

^[3] Fits blastpots up to 560mm width. Max height 2,3m.













^[4] Suitable for suction hose PU12 Ø51mm with coupler 40377028

^[5] Flap valve 43885001 can be used on the inlet













Accessories

	Accessory	Item number
	Discharge valve manual	43630001
	Manual butterflyvalve kit, MFC	43630400
	Pinch valve DN65	43632001
	Pinch valve DN80	43632100
	Pinch valve DN100	43632200
	Disch valve w/counterwt	43630200
	Discharge valve pneum	43630100
	Discharge valve Linatex d100 set w/	43630300
	ATEX-goedgekeurde stofbakniveau-indicator voor veilige bewaking in gevaarlijke omgevingen met gedetailleerde gebruikersinstructies.	40375269
	Plastic bag S50 - 25pcs 630x800	43650104
	Joint sleeve 65	40377028
	Joint sleeve 76mm, hoseclamp included	40130990
	Zuigslang PU12 Ø 51 mm L=10m	43832600









Accessories

	Accessory	Item number
	Zuigslang PU12 Ø 51 mm L=5m	43832500
	Zuigslang PU12 Ø 51 mm L=20m	43832300
	Zuigslang PU12 Ø 51 mm L=7,5m met koppelingen	43832102
	Hose PU12-51 L=10m w. couplers	43832200
	Zuigslang PU12 Ø 63 mm L=5m	43833200
	Zuigslang PU12 Ø 63 mm L=10m	43833001
	Zuigslang PU12 Ø 63 mm L=20m	43833100
	Reinigingsset compleet Ø51 mm / 500 mm	42932100
	Reinigingsset compleet Ø51 mm / 400 mm	42932800
	Reinigingsset compleet Ø51 mm / 400 mm	42932300
	Vloerzuigmond Ø51 mm, 500 mm breed	43840150
	Vloerzuigmond Ø51 mm, 400 mm breed	43840250
	Vloerzuigmond met borstels, Ø51 mm, 400 mm breed	43840550

Accessories

	Accessory	Item number
	Handmondstuk, harde borstel d51	43860001
	Handmondstuk pp d51	43861001
	Conisch mondstuk d51	43862001
	Elleboogpijp Ø 51 mm antistatisch	43842150
	Zuigbuis Ø51 mm, PEHD-EL 1 meter	43842001
	Harde borstel met handgreep d51	43850150
	Harde borstel d51	43850001
	Schraapgereedschap L=1000mm Ø 51 mm	43851150
	Schraapgereedschap L=500mm Ø 51 mm	43851050
	Spaanmondstuk Ø 50 mm	40150030
	Vloerzuigkop 500 mm breed, Ø 63	43840400
	Harde borstel d63	43850050
	Harde borstel d63 handvat	43850051

Accessories

	Accessory	Item number
	Harde borstel met handgreep d63	43850200
	Schraapgereedschap L=1000mm Ø 63 mm	43851200
	Aluminium zuigleiding Ø63	43843001
	Aluminium bocht Ø63	43843050
	Stalen draaikoppeling d63	43843100
	Hose PU12-76 L=2,5m	43834500
	Control S for NE 22-76	43220001
	Control S for NE 22-76, wo/control box	43220026
	Control S for NE86-96, wo/control box	43222008

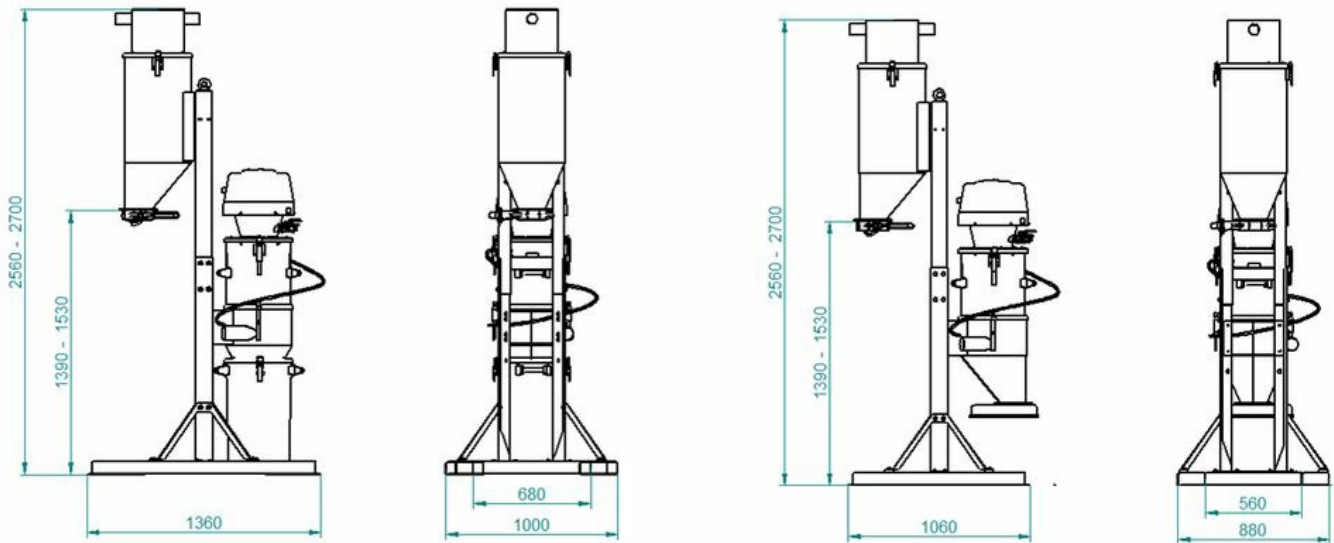

The height of your configuration is depending on which modules you choose

Ejector/Hose dimension	ø51mm	ø63mm	ø76mm
NE52	2	N/A	N/A
NE64	2	2,4	N/A
NE74	2,3	2,7	N/A
NE76	1,7	2,7	3,6
NE96	2,6	3,6	4,9

Capacity (tonne/hour) with Blasting media 2,4kg/liter and 20m hose

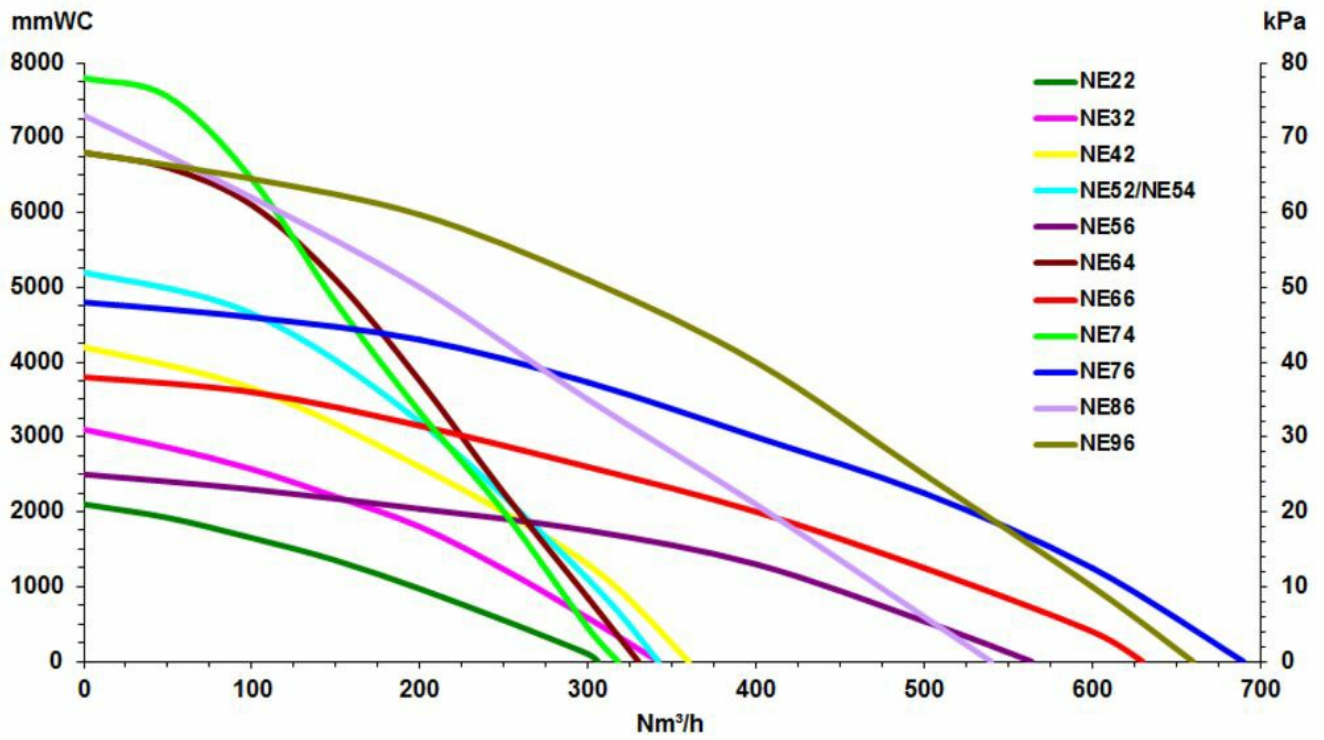

Air Powered ejectors All performance data are based on 7 bar supply pressure