

570A, Configurable

A powerful dust collector, excellent high vacuum for suction over long horizontal and vertical distances



570A, Configurable

- ✓ Silo system with large wheels
- ✓ Suitable for heavy and or abrasive material
- ✓ Robust and efficient self-cleaning filter

The configuration of modules will be similar to 570A which are aimed for the toughest applications, for example handling a lot of abrasive and heavy material. The robustness of the unit and the power from the reliable ejector makes the unit very suitable for many applications where many industrial vacuum cleaners can not be used. For example to collect blasting material in blasting hall, sand recovery in foundries etc.

Your unit can be configured to meet your specific demands. Different ejectors can be used depending on the demand but also the availability of compressed air. The ejector can be placed on a mobile silo with filter, with wheels and forklift slots. Nederman has a range of different discharge valves that can be fitted to the silo for easy discharge of the collected material. If handling larger quantities of material, Nederman recommends using a pre separator before the vacuum unit. See Nederman Engineering Guide for more information.

Use modules linked to 570A, configurable only. You may only choose ejectormodule, filtermodule, silomodule and discharge valve

1. Select ejectormodule depending on required vacuum and air flow.
2. Select filtermodule depending on filter capacity.
3. Select silomodule.
4. Select discharge valve.
5. Select cleaning equipment.

Choose how to control your butterfly valve:

1. Electric controlled - You need a namur valve, solenoid valve recommended for the ejector size you choose and a control box.
2. Air controlled - You need a namur valve.







Hose for air supply to the namur valve is not supplied by Nederman.

Control system with many different functions is available as an accessory
Ensure you meet all requirements for your modules.

570A, Configurable

Sertifiseringer	CE
Rengjøringsmetode, filter	[CompressedAir]
Bruksområde	Støv, [granulate], [grit], [swarf]













Models

	Item number	[ItemCompressedAirRequirement]	[ItemMaxAirFlow]	[ItemMaxVaccum]	Vekt (kg)	Filtertype	Antall filterelementer
	43051000 ^[1]	4,3 Nm ³ /min @ 7 bar	330 Nm ³ /h	-68	18		
	43051001 ^[1]	5,3 Nm ³ /min @ 7 bar	318 Nm ³ /h	-78	18		
	43051002 ^[2]	5,4 Nm ³ /min @ 7 bar	690 Nm ³ /h	-48	18		
	43051003 ^[2]	8,6 Nm ³ /min @ 7 bar	660 Nm ³ /h	-68	18		
	43162101				40	Kuvertfilter	70
	43164101				55	Kuvertfilter	70
	43470034				80		













^[1] Recommended with filtermodule 43162101

^[2] Recommended with filtermodule 43164101













Accessories

	Accessory	Item number
	Utslippsventil manuell	43630001
	Diskventil m/motv.	43630200
	Utslippsventil pneum	43630100
	Klypeventil DN65	43632001
	Klypeventil DN80	43632100
	Manual butterflyvalve kit, MFC	43630400
	Slange PU12-51 L=10 m	43832600
	Slange PU12-51 L=5m	43832500
	Slange PU12-51 L=20 m	43832300
	Slange PU12-51 L=7,5m med koblinger	43832102
	Slange PU12-51 L=10 m m/koblinger	43832200
	Slange PU12-63 L=5m	43833200
	Slange PU12-63 L=10 m	43833001













Accessories

	Accessory	Item number
	Slange PU12-63 L=20 m	43833100
	Slange PU12-76 L=10 m	43834200
	Slange PU12-76 L=20 m	43834300
	Monteringsplate for 0802010 +0801020	43690001
	Control System for Ejectors	43220034
	BLI EX	40375269
	Avsugstst. kompl. d51/500	42932100
	Avsugstst. kompl. d51/400	42932800
	Avsugstst. kompl. d51/400	42932300
	Sugehode,gulv d51/500	43840150
	Sugehode,gulv d51/400/65	43840250
	Børstesugehode d51/400	43840550
	Håndsugsenh stiv børste d51	43860001

Accessories

	Accessory	Item number
	Handavsugshode pp d51	43861001
	Konisk munnstykke d51	43862001
	Sugerørbøy d51 antist	43842150
	Sugerør d51 PEHD-el 1m	43842001
	Sugemunnstykke d51 m/håndtak	43850150
	Sugemunnstykke d51	43850001
	Skrapeverktøy d51 I1000	43851150
	Skrapeverktøy d51 I500	43851050
	Munnstykke spon D=50 mm	40150030
	Sugehode,gulv d63/500	43840400
	Sugemunnstykke d63	43850050
	Sugemunnstykke d63 hatch	43850051
	Sugemunnstykke d63 m/håndtak	43850200

Accessories

	Accessory	Item number
	Skrapeverktøy d63 l1000	43851200
	Sugerørby alum d63	43843050
	Stålsvivel d63	43843100
	Sugerør alum d63	43843001
	Skrapeverktøy d63 l500	43851100
	Sugemunnstykke d76	43850100
	Sugemunnstykke d76 m/håndtak	43850250
	Skrapeverktøy d76 l1000	43851250
	Slange rød konisk d76-63	43880350
	Rød konisk d76-51	43880300
	Slange rød konisk d63-51	43880250
	Slangekobling d63	43880100
	Slangekobling d50	43880050

Accessories

	Accessory	Item number
	Slangekobling konisk d76	43880150
	Kontroll Sfor NE 22-76	43220001
	Kontroll Sfor NE 22-76	43220026
	Kontroll Sfor NE86-96	43222008
	Sugehode, gulv d63/600	43840450

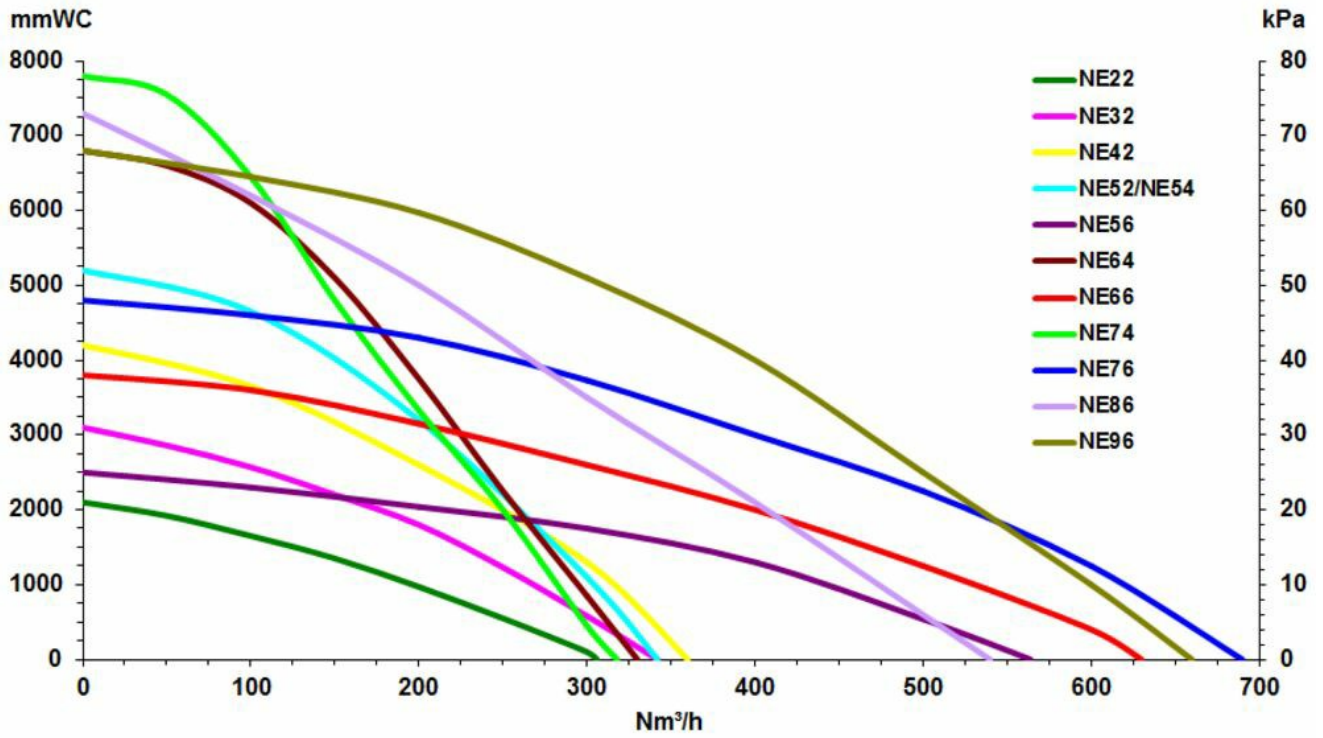

Air Powered ejectors All performance data are based on 7 bar supply pressure

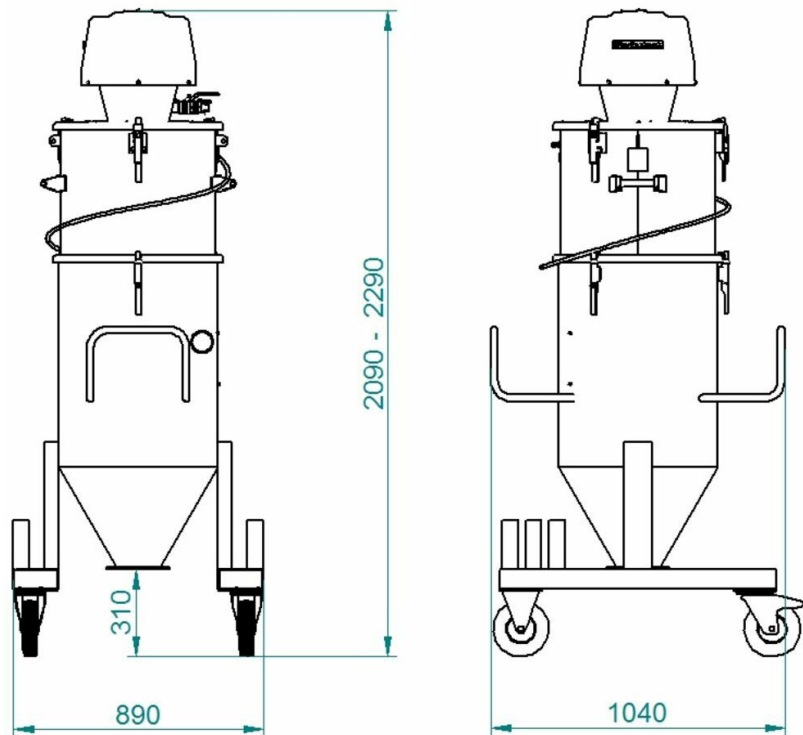

The height of the configuration is depending on filtermodule choosen.

Ejector/Hose dimension	ø51mm	ø63mm	ø76mm
NE64	2	2,4	N/A
NE74	2,3	2,7	N/A
NE76	1,7	2,7	3,6
NE96	2,6	3,6	4,9

Capacity (tonne/hour) with Blasting media 2,4kg/liter and 20m hose