

# 600A, Configurable

A powerful dust collector, for suction over long horizontal and vertical distance



## 600A, Configurable

- ✓ Robust and efficient self-cleaning filter
- ✓ Very powerful and reliable ejector as vacuum producer
- ✓ Suitable for heavy and/or abrasive material
- ✓ Control system with many different functions is available as an accessory

The configuration of modules will be similar to 600A which are aimed for the toughest applications, for example handling a lot of abrasive and heavy material. The robustness of the unit and the power from the reliable ejector makes the unit very suitable for many applications where many industrial vacuum cleaners can not be used. For example to collect blasting material in blasting hall, sand recovery in foundries etc.

Your unit can be configured to meet your specific demands. Different ejectors can be used depending on the demand but also the availability of compressed air. The ejector can be placed on a stationary silo with filter.

A range of different discharge valves that can be fitted to the silo for easy discharge of the collected material. If handling larger quantities of material, Nederman recommends using a pre separator before the vacuum unit.

To configure your 600A you may only choose ejectormodule, filtermodule, silomodule and discharge valve listed in this document and with mfc (module for configuration) in title.

1. Select ejectormodule depending on required vacuum and air flow.
2. Select filtermodule depending on filter capacity.
3. Select silomodule.
4. Select discharge valve.
5. Select cleaning equipment.

Choose how to control your butterfly valve:

1. Electric controlled - You need a namur valve, solenoid valve recommended for the ejector size you choose and a control box.
2. Air controlled - You need a namur valve.









Hose for air supply to the namur valve is not supplied by Nederman.

Ensure that all requirements for the modules are met. The height of your configuration is depending on what filtermodule and legs you choose.

## 600A, Configurable

Certifications	CE
Filter cleaning method	Compressed air
Application	Granulate, Grit, Swarf, Dust

## Models

	Item no	Compressed air requirement	Max airflow (m <sup>3</sup> /h)	Max vacuum (kPa)	Weight (kg)	Filter type	Number of filter elements
	43051000 <sup>[1]</sup>	4,3 Nm <sup>3</sup> /min @ 7 bar	330 Nm <sup>3</sup> /h	-68	18		
	43752001						
	43756001 <sup>[2]</sup>						
	43756100 <sup>[2]</sup>						
	43757001 <sup>[3]</sup>						
	43051001 <sup>[1]</sup>	5,3 Nm <sup>3</sup> /min @ 7 bar	318 Nm <sup>3</sup> /h	-78	18		
	43051002 <sup>[4]</sup>	5,4 Nm <sup>3</sup> /min @ 7 bar	690 Nm <sup>3</sup> /h	-48	18		
	43051003 <sup>[4]</sup>	8,6 Nm <sup>3</sup> /min @ 7 bar	660 Nm <sup>3</sup> /h	-68	18		
	43164101				55	[NCF]	70













<sup>[1]</sup> Recommended with filtermodule 43162101

<sup>[2]</sup> Each configuration needs the quantity of three legs, so to get a complete product you need to order three pieces of chosen number













<sup>[3]</sup> To be used with 43756100, order three pieces

<sup>[4]</sup> Recommended with filtermodule 43164101













## Accessories

	Accessory	Item no
	Discharge valve manual	43630001
	Pinch valve DN65	43632001
	Manual butterflyvalve kit, MFC	43630400
	Pinch valve DN80	43632100
	Pinch valve DN100	43632200
	Disch valve w/counterwt	43630200
	Discharge valve pneum	43630100
	Discharge valve Linatex d100 set w/	43630300
	Bagholder f/0920220/230	43640001
	Bagholder f/0920210	43640003
	Plastic bag S50 - 25pcs 630x800	43650104
	Bagholder f/big bag	43640201
	Bagholder for big bag, MFC	43640217













## Accessories

	Accessory	Item no
	Control Sfor NE 22-76	43220026
	Control Sfor NE86-96	43222008
	Control Sfor NE 22-76	43220001
	Control Sfor NE86-96	43222001
	Mountingplate f/0802010 +0801020	43690001
	Hose PU12-51 L=10m	43832600
	Hose PU12-51 L=5m	43832500
	Hose PU12-51 L=20m	43832300
	Hose PU12-51 L=7,5m w. couplings	43832102
	Hose PU12-51 L=10m w. couplers	43832200
	Hose PU12-63 L=5m	43833200
	Hose PU12-63 L=10m	43833001
	Hose PU12-63 L=20m	43833100





## Accessories

	Accessory	Item no
	Hose PU12-76 L=10m	43834200
	Hose PU12-76 L=20m	43834300
	Suct equip compl d51/500	42932100
	Suct equip compl d51/400	42932800
	Suct equip compl d51/400	42932300
	Floor suct head d51/500	43840150
	Floor suct headd51/400/65	43840250
	Brush suct head d51/400	43840550
	Hand suct h stiff brushd51	43860001
	Hand suct head pp d51	43861001
	Conical nozzle d51	43862001
	Suct pipe bend d51 artist	43842150
	Suction pipe d51 PEHD-el 1m	43842001

## Accessories

	Accessory	Item no
	Gulper head d51 w/handle	43850150
	Gulper head d51	43850001
	Scraping tool d51 l1000	43851150
	Scraping tool d51 l500	43851050
	Nozzle swarf D=50mm	40150030
	Floor suct head d63/500	43840400
	Gulper head d63	43850050
	Gulper head d63 hatch	43850051
	Gulper head d63 w/handle	43850200
	Scraping tool d63 l1000	43851200
	Suct pipe bend alum d63	43843050
	Swivel steel d63	43843100
	Suction pipe alum d63	43843001

## Accessories

	Accessory	Item no
	Scraping tool d63 l500	43851100
	Gulper head d76	43850100
	Gulper head d76 w/handle	43850250
	Scraping tool d76 l1000	43851250
	BLI EX	40375269
	Hose connect conical d76	43880150
	Floor suct head d63/600	43840450

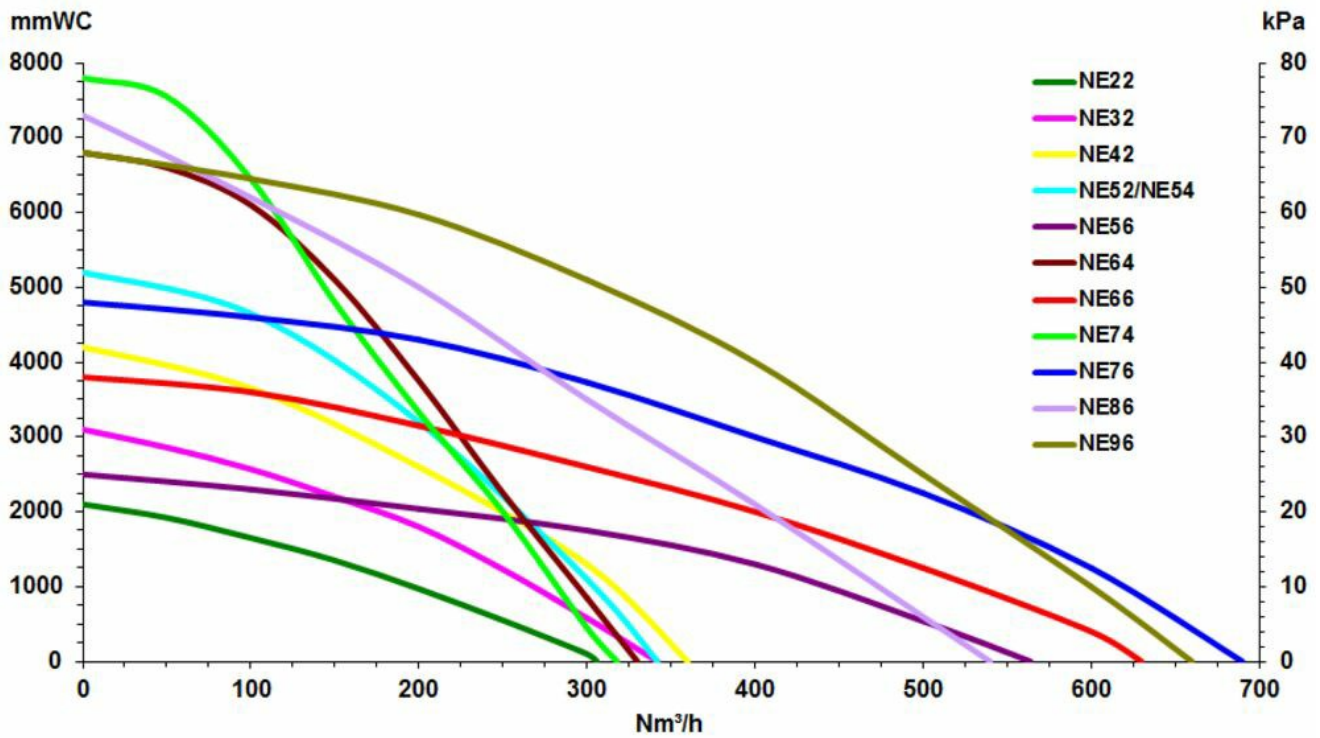

Air Powered ejectors All performance data are based on 7 bar supply pressure

Ejector/Hose dimension	ø51mm	ø63mm	ø76mm
NE64	2	2,4	N/A
NE74	2,3	2,7	N/A
NE76	1,7	2,7	3,6
NE96	2,6	3,6	4,9

Capacity (tonne/hour) with Blasting media 2,4kg/liter and 20m hose

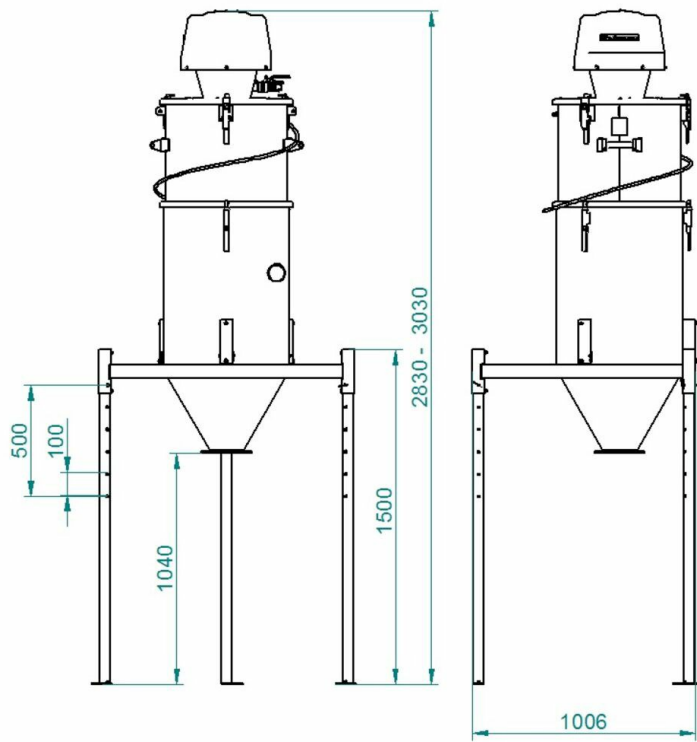

Dimensions with 1 500 mm legs

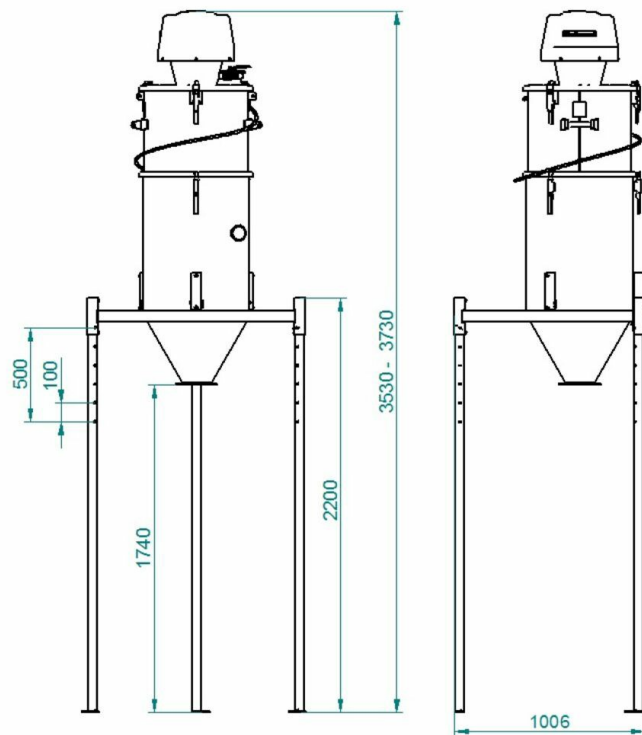

Dimensions with 2 200 mm legs