

Product leaflet

600A, Configurable

A powerful dust collector, for suction over long horizontal and vertical distance



600A, Configurable

- ✓ Robust and efficient self-cleaning filter
- ✓ Very powerful and reliable ejector as vacuum producer
- ✓ Suitable for heavy and/or abrasive material
- ✓ Control system with many different functions is available as an accessory

The configuration of modules will be similar to 600A which are aimed for the toughest applications, for example handling a lot of abrasive and heavy material. The robustness of the unit and the power from the reliable ejector makes the unit very suitable for many applications where many industrial vacuum cleaners can not be used. For example to collect blasting material in blasting hall, sand recovery in foundries etc.

Your unit can be configured to meet your specific demands. Different ejectors can be used depending on the demand but also the availability of compressed air. The ejector can be placed on a stationary silo with filter.

A range of different discharge valves that can be fitted to the silo for easy discharge of the collected material.

If handling larger quantities of material, Nederman recommends using a pre separator before the vacuum unit.

To configure your 600A you may only choose ejectormodule, filtermodule, silomodule and discharge valve listed in this document and with mfc (module for configuration) in title.

1. Select ejectormodule depending on required vacuum and air flow.
2. Select filtermodule depending on filter capacity.
3. Select silomodule.
4. Select discharge valve.
5. Select cleaning equipment.

Choose how to control your butterfly valve:

1. Electric controlled - You need a namur valve, solenoid valve recommended for the ejector size you choose and a control box.
2. Air controlled - You need a namur valve.

Hose for air supply to the namur valve is not supplied by Nederman.

Ensure that all requirements for the modules are met. The height of your configuration is depending on what filtermodule and legs you choose.

600A, Configurable











Sertifiseringer	CE
Rengjøringsmetode, filter	[CompressedAir]
Bruksområde	[granulate], [grit], [swarf], Støv

This content is protected under copyright law, furnished for informational use only, and subject to change without notice. © Nederman Holding AB

2026-02-12

3/11

Models

	Item number	[ItemCompressedAirRequirement]	[ItemMaxAirFlow]	[ItemMaxVaccum]	Vekt (kg)	Filtertype	Antall filterelementer
	43051000 ^[1]	4,3 Nm ³ /min @ 7 bar	330 Nm ³ /h	-68	18		
	43440023				40		
	43752001						
	43756001 ^[2]						
	43756100 ^[2]						
	43757001 ^[3]						
	43051001 ^[1]	5,3 Nm ³ /min @ 7 bar	318 Nm ³ /h	-78	18		
	43051002 ^[4]	5,4 Nm ³ /min @ 7 bar	690 Nm ³ /h	-48	18		
	43051003 ^[4]	8,6 Nm ³ /min @ 7 bar	660 Nm ³ /h	-68	18		
	43164101				55	Kuvertfilter	70

^[1] Recommended with filtermodule 43162101

^[2] Each configuration needs the quantity of three legs, so to get a complete product you need to order three pieces of chosen number

^[3] To be used with 43756100, order three pieces













^[4] Recommended with filtermodule 43164101

This content is protected under copyright law, furnished for informational use only, and subject to change without notice. © Nederman Holding AB

2026-02-12

4/11

Accessories

	Accessory	Item number
	Utslippsventil manuell	43630001
	Klypeventil DN65	43632001
	Manual butterflyvalve kit, MFC	43630400
	Klypeventil DN80	43632100
	Klypeventil DN100	43632200
	Diskventil m/motv.	43630200
	Utslippsventil pneum	43630100
	Utslippsventil Linatex d100 sett m/	43630300
	Poseholder for 0920220/230	43640001
	Poseholder for 0920210	43640003
	Plastpose S50 - 25 stk 630x800	43650104
	Poseholder for big bag	43640201
	Bagholder for big bag, MFC	43640217













This content is protected under copyright law, furnished for informational use only, and subject to change without notice. © Nederman Holding AB

2026-02-12

5/11

Nederman

600A, Configurable

	Accessory	Item number
	Kontroll Sfor NE 22-76	43220026
	Kontroll Sfor NE86-96	43222008
	Kontroll Sfor NE 22-76	43220001
	Kontroll Sfor NE86-96	43222001
	Monteringsplate for 0802010 +0801020	43690001
	Control System for Ejectors	43220034
	Slange PU12-51 L=10 m	43832600
	Slange PU12-51 L=5m	43832500
	Slange PU12-51 L=20 m	43832300
	Slange PU12-51 L=7,5m med koblinger	43832102
	Slange PU12-51 L=10 m m/koblinger	43832200
	Slange PU12-63 L=5m	43833200
	Slange PU12-63 L=10 m	43833001

This content is protected under copyright law, furnished for informational use only, and subject to change without notice. © Nederman Holding AB













2026-02-12

6/11

Nederman

600A, Configurable

Accessories

	Accessory	Item number
	Slange PU12-63 L=20 m	43833100
	Slange PU12-76 L=10 m	43834200
	Slange PU12-76 L=20 m	43834300
	Avsugstst. kompl. d51/500	42932100
	Avsugstst. kompl. d51/400	42932800
	Avsugstst. kompl. d51/400	42932300
	Sugehode,gulv d51/500	43840150
	Sugehode,gulv d51/400/65	43840250
	Børstesugehode d51/400	43840550
	Håndsugsenh stiv børste d51	43860001
	Handavsugshode pp d51	43861001
	Konisk munnstykke d51	43862001
	Sugerørbøy d51 antist	43842150

This content is protected under copyright law, furnished for informational use only, and subject to change without notice. © Nederman Holding AB

2026-02-12













7/11

Nederman

600A, Configurable

Accessories

Accessory	Item number
-----------	-------------

	Accessory	Item number
	Sugerør d51 PEHD-el 1m	43842001
	Sugemunnstykke d51 m/håndtak	43850150
	Sugemunnstykke d51	43850001
	Skrapeverktøy d51 I1000	43851150
	Skrapeverktøy d51 I500	43851050
	Munnstykke spon D=50 mm	40150030
	Sugehode,gulv d63/500	43840400
	Sugemunnstykke d63	43850050
	Sugemunnstykke d63 hatch	43850051
	Sugemunnstykke d63 m/håndtak	43850200
	Skrapeverktøy d63 I1000	43851200
	Sugerørbøy alum d63	43843050
	Stålsvivel d63	43843100

This content is protected under copyright law, furnished for informational use only, and subject to change without notice. © Nederman Holding AB

2026-02-12













8/11

Nederman

600A, Configurable

Accessories

Accessory	Item number
-----------	-------------

	Accessory	Item number
	Sugerør alum d63	43843001
	Skrapeverktøy d63 I500	43851100
	Sugemunnstykke d76	43850100
	Sugemunnstykke d76 m/håndtak	43850250
	Skrapeverktøy d76 I1000	43851250
	Slange rød konisk d76-63	43880350
	Rød konisk d76-51	43880300
	Slange rød konisk d63-51	43880250
	Slangekobling d63	43880100
	Slangekobling d50	43880050
	BLI EX	40375269
	Slangekobling konisk d76	43880150
	Sugehode, gulv d63/600	43840450

This content is protected under copyright law, furnished for informational use only, and subject to change without notice. © Nederman Holding AB

2026-02-12

9/11

Nederman

600A, Configurable



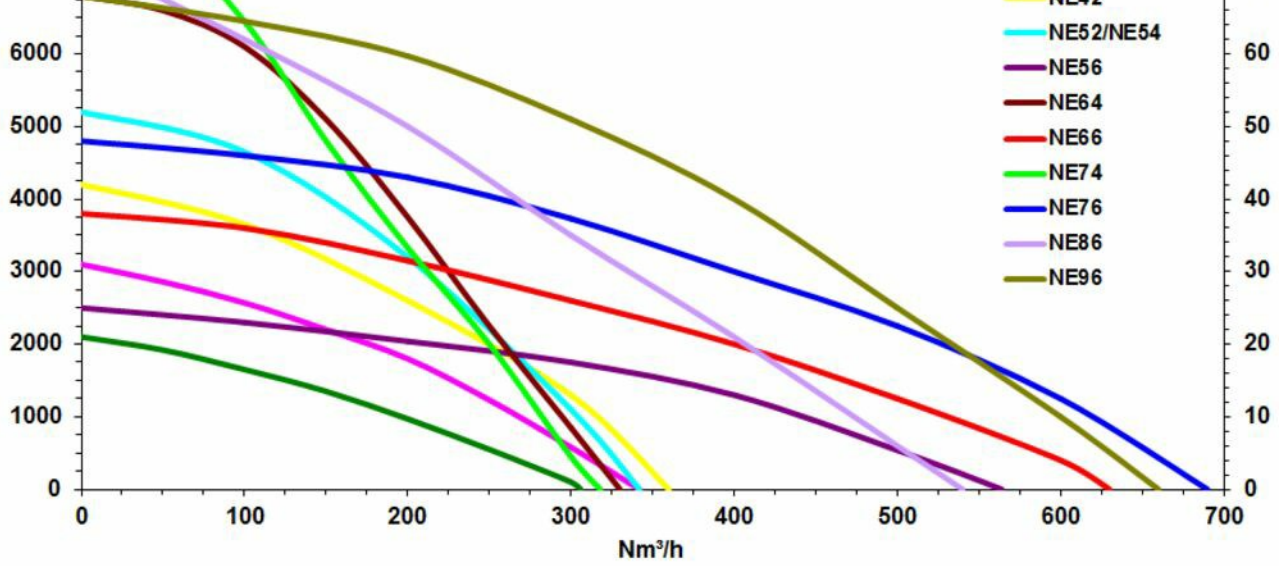

Air Powered ejectors All performance data are based on 7 bar supply pressure

Ejector/Hose dimension	ø51mm	ø63mm	ø76mm
NE64	2	2,4	N/A
NE74	2,3	2,7	N/A
NE76	1,7	2,7	3,6
NE96	2,6	3,6	4,9

Capacity (tonne/hour) with Blasting media 2,4kg/liter and 20m hose

This content is protected under copyright law, furnished for informational use only, and subject to change without notice. © Nederman Holding AB

2026-02-12

10/11

Nederman

600A, Configurable

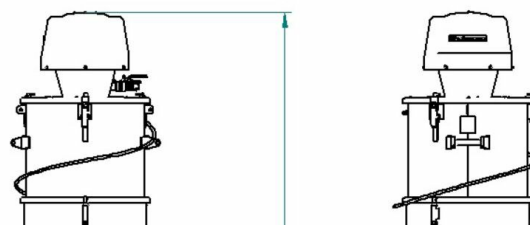

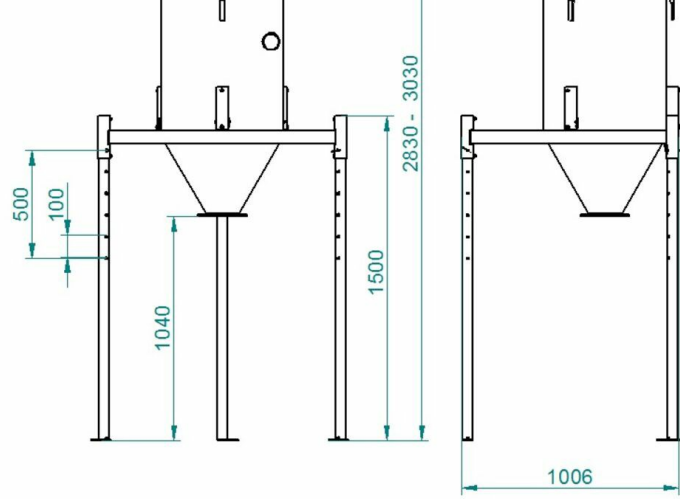

Dimensions with 1 500 mm legs

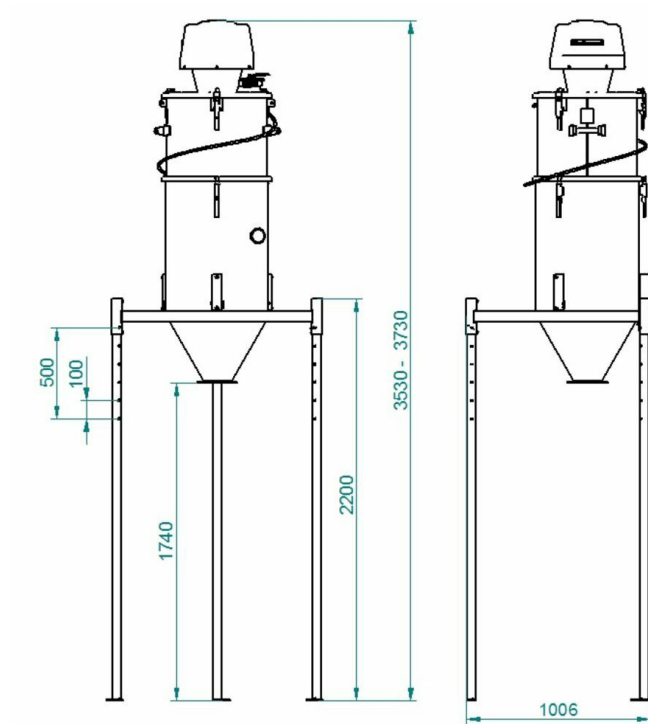

Dimensions with 2200 mm legs