

710A, Configurable.

A powerful dust collector, excellent high vacuum for suction over long horizontal and vertical distance



710A, Configurable.

- ✓ Robust and efficient self-cleaning filter
- ✓ Very powerful and reliable ejector as vacuum producer
- ✓ Suitable for heavy and/or abrasive material
- ✓ Control system with many different functions is available as an accessory

Nederman Pre-separation and Vacuum Transportation Systems pre-separate and discharge dust and granulated material during vacuuming and vacuum transport.

A system can handle dry material like cement, fertilizers, grit, sand, as well as wet material. Collected material can be discharged into tanks, containers, big-bags, on to conveyor belts, escalators etc.

The configuration of modules will be similar to 710A which are aimed for the toughest applications, for example handling a lot of abrasive and heavy material. The robustness of the unit and the power from the reliable ejector makes the unit very suitable for many applications where many industrial vacuum cleaners can not be used. For example to collect blasting material in blasting hall, sand recovery in foundries etc.

Your unit can be configured to meet your specific demands. Different ejectors can be used depending on the demand but also the availability of compressed air. The ejector can be placed on a stationary silo with filter.

Nederman has a range of different discharge valves that can be fitted to the silo for easy discharge of the collected material. If handling larger quantities of material and in order to make the material handling more effective Nederman recommends using a pre separator before the vacuum unit. The 710A is a complete unit including a pre separator.

To configure your 710A you may only choose modules listed in this document and with mfc (module for configuration) in title. Filterside:

1. Select ejectormodule depending on required vacuum and air flow.
2. Select filtermodule depending on filter capacity.
3. Select silomodule.
4. Select disposal option, bagholder and discharge valve.
5. Select frame.

Separatorside:

1. Select coarse grain separator.
2. Select silomodule.
3. Select discharge valve.
4. Select frame.
5. Select hose for connection between vacuum cleaner and separator.
6. Select joint sleeve depending on coarse grain separator and hose.
7. Select cleaning equipment.

Choose how to control your butterfly valve:

1. Electric controlled
 - You need a namur valve, solenoid valve recommended for the ejector size you choose and a suitable control box.
2. Air controlled...

710A, Configurable.

证书	CE
应用	颗粒物, 沙砾, 切屑, 粉尘

模型

	项目编号	[ItemCompressedAirRequirement]	[ItemMaxAirFlow]	[ItemMaxVaccum]	重量 (公斤)	除尘器类型	滤芯数量
	43051000 ^[1]	4,3 Nm ³ /min @ 7 bar	330 Nm ³ /h	-68	18		
	43750001						
	43441001						
	43561001						
	43661008						
	43051001 ^[1]	5,3 Nm ³ /min @ 7 bar	318 Nm ³ /h	-78	18		
	43051002 ^[2]	5,4 Nm ³ /min @ 7 bar	690 Nm ³ /h	-48	18		
	43051003 ^[2]	8,6 Nm ³ /min @ 7 bar	660 Nm ³ /h	-68	18		
	43164101				55	蜡烛过滤器	70
	43461007						
	43752001						
	43756001 ^[3]						
	43756100 ^[3]						

模型

	项目编号	[ItemCompressedAirRequirement]	[ItemMaxAirFlow]	[ItemMaxVaccum]	重量 (公斤)	除尘 器类 型	滤芯 数量
	43757001 ^[4]						







^[1] Recommended with filtermodule 43162101

^[2] Recommended with filtermodule 43164101













^[3] Each configuration needs the quantity of three legs, so to get a complete product you need to order three pieces of chosen number

^[4] To be used with 43756100, order three pieces













配件

	配件	项目编号
	手动卸料阀	43630001
	脉冲阀DN65	43632001
	Manual butterflyvalve kit, MFC	43630400
	脉冲阀DN80	43632100
	脉冲阀DN100	43632200
	平衡卸料阀	43630200
	气动卸料阀	43630100
	Discharge valve Linatex d100 set w/	43630300
	收集袋支架 0920220/230	43640001
	收集袋支架 用于0920210	43640003
	夹袋器 用于大型袋子	43640201
	Bagholder for big bag, MFC	43640217
	控制器 用于NE 22-76	43220026













配件

	配件	项目编号
	控制器 用于NE86-96	43222008
	控制器	43220001
	控制器	43222001
	安装平板0802010 +0801020	43690001
	Control System for Ejectors	43220034
	Hose PU12-51 L=10m	43832600
	Hose PU12-51 L=5m	43832500
	PU管d51, 20m	43832300
	Hose PU12-51 L=7,5m w. couplings	43832102
	PU管d51, 10m	43832200
	Hose PU12-63 L=5m	43833200
	PU管d63, 10m	43833001
	PU管d63, 20m	43833100













配件

	配件	项目编号
	PU管d76, 10m	43834200
	PU管 d76 20m	43834300
	吸口装置总成 d51/500	42932100
	吸口装置总成 d51/400	42932800
	吸口装置总成 d51/400	42932300
	地板吸头 d51/500	43840150
	地板吸头 d51/400/65	43840250
	带毛刷地板吸头 d51/400	43840550
	手持抽吸头带毛刷d51	43860001
	手持抽吸头PPd51	43861001
	手持锥形抽吸头d51	43862001
	抽排管防静电弯头 d51	43842150
	抽排管 d51 pehd-el 1m	43842001



配件

	配件	项目编号
	强力吸头带手柄 d51	43850150
	强力吸头 d51	43850001
	铁屑抽吸装置 d51 l1000	43851150
	铁屑抽吸装置 d51 l500	43851050
	木屑/金属屑吸嘴, D=50mm	40150030
	地板吸头 d63/500	43840400
	强力吸头 d63	43850050
	Gulper head d63 hatch	43850051
	强力吸头带手柄 d63	43850200
	铁屑抽吸装置 d63 l1000	43851200
	抽排铝管弯头 d63	43843050
	钢旋转街头 d63	43843100
	抽排铝管 d63	43843001

配件

	配件	项目编号
	铁屑抽吸装置 d63 I500	43851100
	强力吸头 d76	43850100
	强力吸头带手柄 d76	43850250
	铁屑抽吸装置 d76 11000	43851250
	软管锥形变径 d76-63	43880350
	软管锥形变径 d76-51	43880300
	软管锥形变径 d63-51	43880250
	软管接头 d63	43880100
	软管接头 d50	43880050
	通过 ATEX 认证的料桶液位计, 可在危险环境中进行安全监测, 并配有详细的用户手册说明。	40375269
	Joint sleeve d75-89/d53-63mm	43884464
	Joint sleeve d65-75	43884463
	Joint sleeve d98-114/d70-88	43884462

配件

	配件	项目编号
	软管锥形接头 d76	43880150
	地板吸头 d63/600	43840450

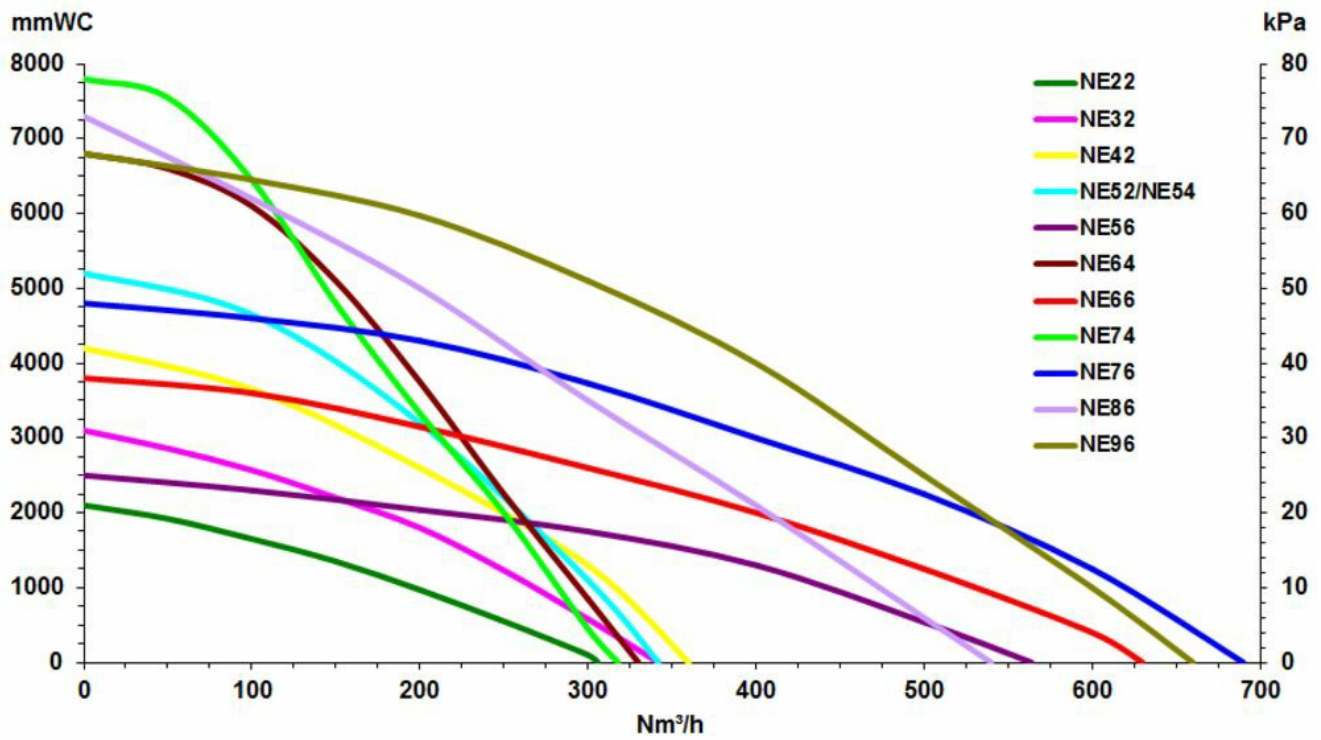

Air Powered ejectors All performance data are based on 7 bar supply pressure

Ejector/Hose dimension	ø51mm	ø63mm	ø76mm
NE64	2	2,4	N/A
NE74	2,3	2,7	N/A
NE76	1,7	2,7	3,6
NE96	2,6	3,6	4,9

Capacity (tonne/hour) with Blasting media 2,4kg/liter and 20m hose

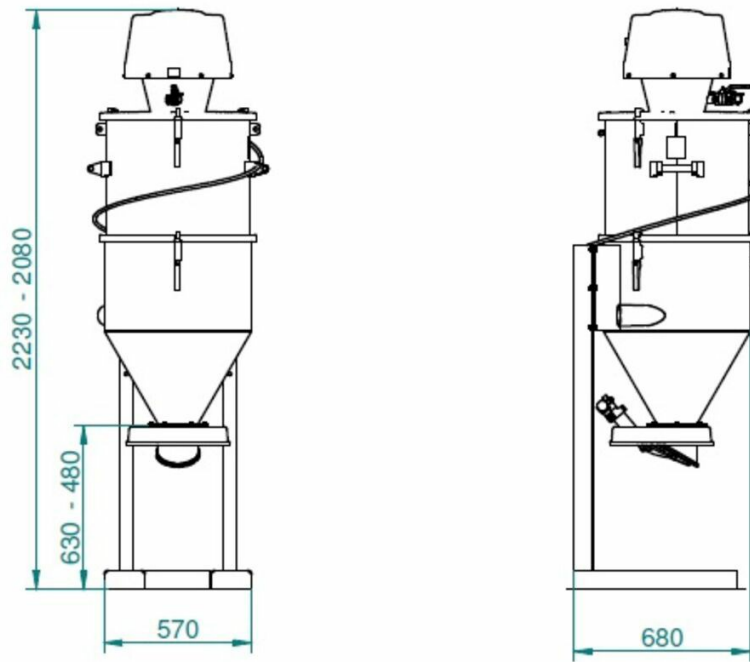

Dimensions - Filter part

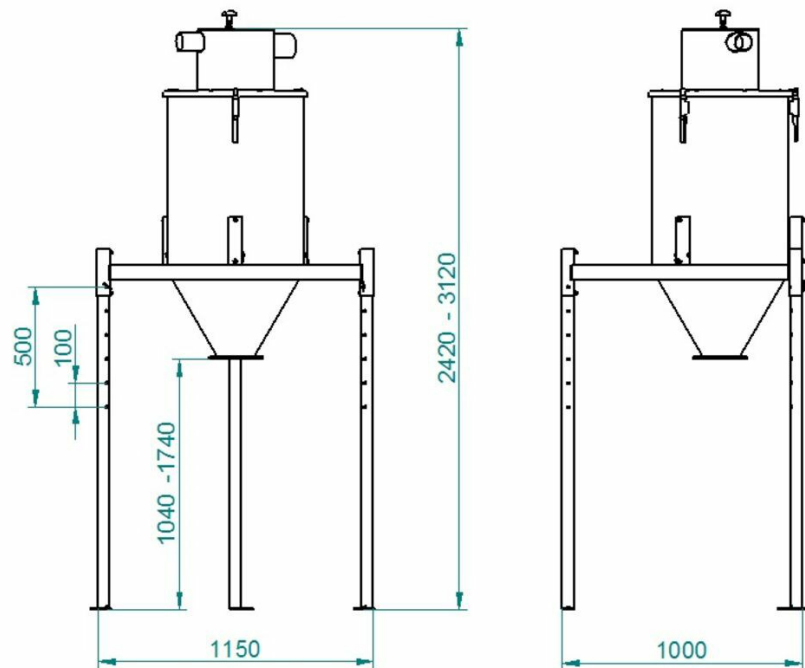

Dimensions pre-separation part