

710A, Configurable.

A powerful dust collector, excellent high vacuum for suction over long horizontal and vertical distance



This content is protected under copyright law, furnished for informational use only, and subject to change without notice. © Nederman Holding AB

2026-06-08

1/13

- ✓ Robust and efficient self-cleaning filter
- ✓ Very powerful and reliable ejector as vacuum producer
- ✓ Suitable for heavy and/or abrasive material
- ✓ Control system with many different functions is available as an accessory

Nederman Pre-separation and Vacuum Transportation Systems pre-separate and discharge dust and granulated material during vacuuming and vacuum transport.

A system can handle dry material like cement, fertilizers, grit, sand, as well as wet material. Collected material can be discharged into tanks, containers, big-bags, on to conveyor belts, escalators etc.

The configuration of modules will be similar to 710A which are aimed for the toughest applications, for example handling a lot of abrasive and heavy material. The robustness of the unit and the power from the reliable ejector makes the unit very suitable for many applications where many industrial vacuum cleaners can not be used. For example to collect blasting material in blasting hall, sand recovery in foundries etc.

Your unit can be configured to meet your specific demands. Different ejectors can be used depending on the demand but also the availability of compressed air. The ejector can be placed on a stationary silo with filter.

Nederman has a range of different discharge valves that can be fitted to the silo for easy discharge of the collected material.

If handling larger quantities of material and in order to make the material handling more effective Nederman recommends using a pre separator before the vacuum unit. The 710A is a complete unit including a pre separator.

To configure your 710A you may only choose modules listed in this document and with mfc (module for configuration) in title.

Filterside:

1. Select ejectormodule depending on required vacuum and air flow.
2. Select filtermodule depending on filter capacity.
3. Select silomodule.
4. Select disposal option, bagholder and discharge valve.
5. Select frame.

Separatorside:

1. Select coarse grain separator.
2. Select silomodule.
3. Select discharge valve.
4. Select frame.
5. Select hose for connection between vacuum cleaner and separator.
6. Select joint sleeve depending on coarse grain separator and hose.
7. Select cleaning equipment.

Choose how to control your butterfly valve:

1. Electric controlled
 - You need a namur valve, solenoid valve recommended for the ejector size you choose and a suitable control box.
2. Air controlled
 - You need a namur valve...

This content is protected under copyright law, furnished for informational use only, and subject to change without notice. © Nederman Holding AB

2026-06-08

2/13

Nederman

710A, Configurable.

710A, Configurable.

Sertifiseringer	CE
Bruksområde	[granulate], [grit], [swarf], Støv

This content is protected under copyright law, furnished for informational use only, and subject to change without notice. © Nederman Holding AB







2026-06-08









3/13

Nederman

710A, Configurable.

Models

	Item number	[ItemCompressedAirRequirement]	[ItemMaxAirFlow]	[ItemMaxVaccum]	Vekt (kg)	Filtertype	Antall filterelementer	Diameter (mm)	[ItemLength]
	43051000 ^[1]	4,3 Nm ³ /min @ 7 bar	330 Nm ³ /h	-68	18				
	43750001								
	43441001								
	43561001								
	43661008								
	43051001 ^[1]	5,3 Nm ³ /min @ 7 bar	318 Nm ³ /h	-78	18				

	Item number	[ItemCompressedAirRequirement]	[ItemMaxAirFlow]	[ItemMaxVaccum]	Vekt (kg)	Filtertype	Antall filterelementer	Diameter (mm)	[ItemLength]
									
	43051002 ^[2]	5,4 Nm ³ /min @ 7 bar	690 Nm ³ /h	-48	18				
	43051003 ^[2]	8,6 Nm ³ /min @ 7 bar	660 Nm ³ /h	-68	18				
	43164101				55	Kuvertfilter	70		
	43461007								
	43752001								
	43756001 ^[3]								
	43756100 ^[3]								

This content is protected under copyright law, furnished for informational use only, and subject to change without notice. © Nederman Holding AB



2026-06-08

4/13

Nederman

710A, Configurable.

Models

	Item number	[ItemCompressedAirRequirement]	[ItemMaxAirFlow]	[ItemMaxVaccum]	Vekt (kg)	Filtertype	Antall filterelementer	Diameter (mm)	[ItemLength]
	43757001 ^[4]								
	43834100			61				76	5

^[1] Recommended with filtermodule 43162101

^[2] Recommended with filtermodule 43164101













^[3] Each configuration needs the quantity of three legs, so to get a complete product you need to order three pieces of chosen number

^[4] To be used with 43756100, order three pieces

Nederman

710A, Configurable.













Accessories

	Accessory	Item number
	Utslippsventil manuell	43630001
	Klypeventil DN65	43632001
	Manual butterflyvalve kit, MFC	43630400
	Klypeventil DN80	43632100
	Klypeventil DN100	43632200
	Diskventil m/motv.	43630200
	Utslippsventil pneum	43630100
	Utslippsventil Linatex d100 sett m/	43630300
	Poseholder for 0920220/230	43640001
	Poseholder for 0920210	43640003
	Poseholder for big bag	43640201
	Bagholder for big bag, MFC	43640217
	Kontroll Sfor NE 22-76	43220026













Nederman

710A, Configurable.













Accessories

	Accessory	Item number
	Kontroll Sfor NE86-96	43222008
	Kontroll Sfor NE 22-76	43220001
	Kontroll Sfor NE86-96	43222001
	Monteringsplate for 0802010 +0801020	43690001
	Control System for Ejectors	43220034
	Slange PU12-51 L=10 m	43832600
	Slange PU12-51 L=5m	43832500
	Slange PU12-51 L=20 m	43832300
	Slange PU12-51 L=7,5m med koblinger	43832102
	Slange PU12-51 L=10 m m/koblinger	43832200
	Slange PU12-63 L=5m	43833200
	Slange PU12-63 L=10 m	43833001
	Slange PU12-63 L=20 m	43833100

Accessories

	Accessory	Item number
	Slange PU12-76 L=10 m	43834200
	Slange PU12-76 L=20 m	43834300
	Avsugsutst. kompl. d51/500	42932100
	Avsugsutst. kompl. d51/400	42932800
	Avsugsutst. kompl. d51/400	42932300
	Sugehode,gulv d51/500	43840150
	Sugehode,gulv d51/400/65	43840250
	Børstesugehode d51/400	43840550
	Håndavgugshode d51	43860001
	Handavgugshode pp d51	43861001
	Konisk munnstykke d51	43862001
	Sugerørbøy d51 antist	43842150
	Sugerør d51 PEHD-el 1m	43842001













Accessories

	Accessory	Item number
	Sugemunnstykke d51 m/håndtak	43850150
	Sugemunnstykke d51	43850001
	Skrapeverktøy d51 l1000	43851150
	Skrapeverktøy d51 l500	43851050
	Munnstykke spon D=50 mm	40150030
	Sugehode,gulv d63/500	43840400
	Sugemunnstykke d63	43850050
	Sugemunnstykke d63 hatch	43850051
	Sugemunnstykke d63 m/håndtak	43850200
	Skrapeverktøy d63 l1000	43851200
	Sugerørbøy alum d63	43843050
	Stålsvivel d63	43843100
	Sugerør alum d63	43843001

This content is protected under copyright law, furnished for informational use only, and subject to change without notice. © Nederman Holding AB

2026-06-08

9/13

	Accessory	Item number
	Skrapeverktøy d63 l500	43851100
	Sugemunnstykke d76	43850100
	Sugemunnstykke d76 m/håndtak	43850250
	Skrapeverktøy d76 l1000	43851250
	Slange rød konisk d76-63	43880350
	Rød konisk d76-51	43880300
	Slange rød konisk d63-51	43880250
	Slangekobling d63	43880100
	Slangekobling d50	43880050
	BLI EX	40375269
	Joint sleeve d75-89/d53-63mm	43884464
	Joint sleeve d65-75	43884463
	Koblingshylse d98-114/d70-88	43884462

This content is protected under copyright law, furnished for informational use only, and subject to change without notice. © Nederman Holding AB



2026-06-08

10/13

Nederman

710A, Configurable.

Accessories

	Accessory	Item number
	Slangekobling konisk d76	43880150
	Sugehode, gulv d63/600	43840450

Nederman

710A, Configurable.

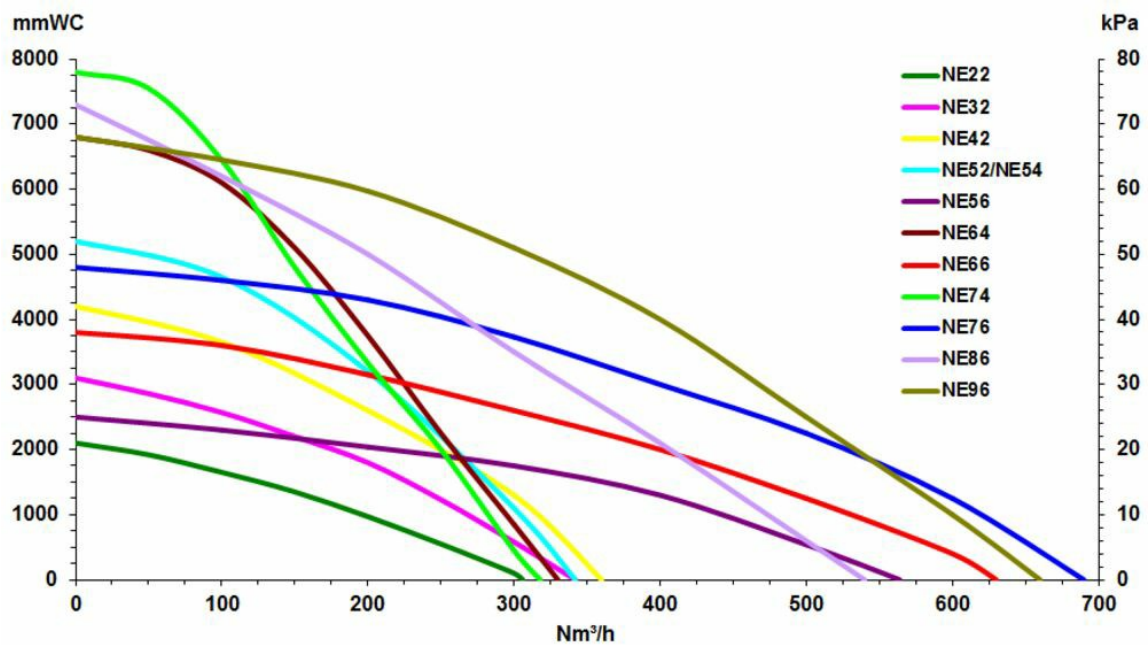

Ejector/Hose dimension	ø51mm	ø63mm	ø76mm
NE64	2	2,4	N/A
NE74	2,3	2,7	N/A
NE76	1,7	2,7	3,6
NE96	2,6	3,6	4,9

Capacity (tonne/hour) with Blasting media 2,4kg/liter and 20m hose

This content is protected under copyright law, furnished for informational use only, and subject to change without notice. © Nederman Holding AB

2026-06-08

12/13

Nederman

710A, Configurable.

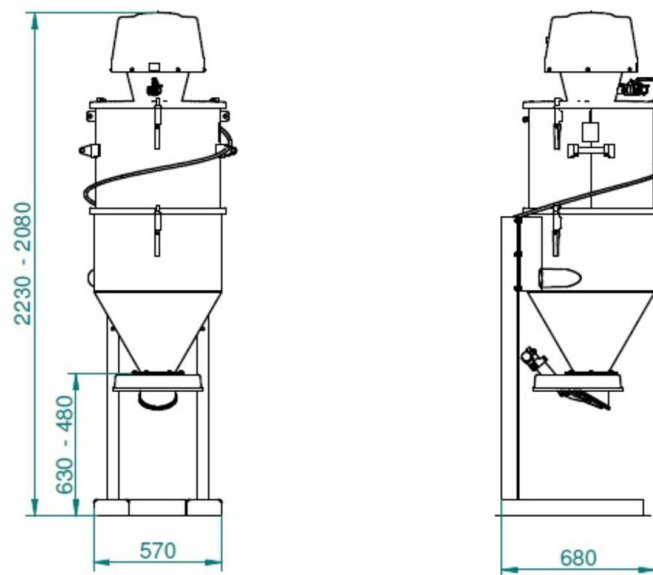

Dimensions - Filter part

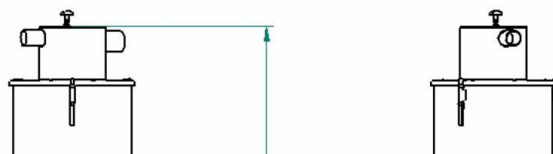

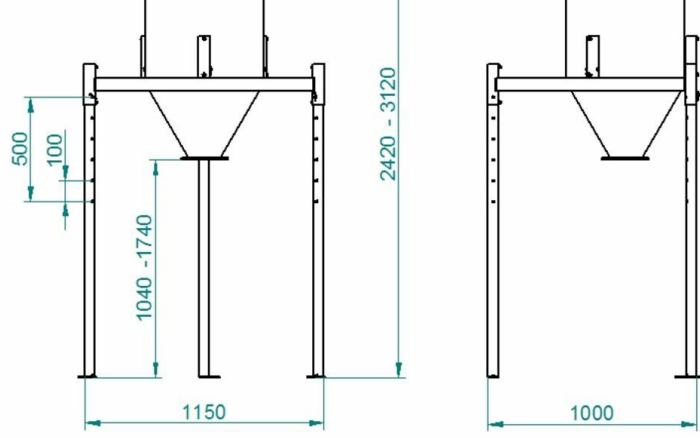

Dimensions pre-separation part

This content is protected under copyright law, furnished for informational use only, and subject to change without notice. © Nederman Holding AB