

710A, Configurable.

A powerful dust collector, excellent high vacuum for suction over long horizontal and vertical distance



This content is protected under copyright law, furnished for informational use only, and subject to change without notice. © Nederman Holding AB

2026-06-08

1/12

- ✓ Robust and efficient self-cleaning filter
- ✓ Very powerful and reliable ejector as vacuum producer
- ✓ Suitable for heavy and/or abrasive material
- ✓ Control system with many different functions is available as an accessory

Nederman Pre-separation and Vacuum Transportation Systems pre-separate and discharge dust and granulated material during vacuuming and vacuum transport.

A system can handle dry material like cement, fertilizers, grit, sand, as well as wet material. Collected material can be discharged into tanks, containers, big-bags, on to conveyor belts, escalators etc.

The configuration of modules will be similar to 710A which are aimed for the toughest applications, for example handling a lot of abrasive and heavy material. The robustness of the unit and the power from the reliable ejector makes the unit very suitable for many applications where many industrial vacuum cleaners can not be used. For example to collect blasting material in blasting hall, sand recovery in foundries etc.

Your unit can be configured to meet your specific demands. Different ejectors can be used depending on the demand but also the availability of compressed air. The ejector can be placed on a stationary silo with filter.

Nederman has a range of different discharge valves that can be fitted to the silo for easy discharge of the collected material.

If handling larger quantities of material and in order to make the material handling more effective Nederman recommends using a pre separator before the vacuum unit. The 710A is a complete unit including a pre separator.

To configure your 710A you may only choose modules listed in this document and with mfc (module for configuration) in title.

Filterside:

1. Select ejectormodule depending on required vacuum and air flow.
2. Select filtermodule depending on filter capacity.
3. Select silomodule.
4. Select disposal option, bagholder and discharge valve.
5. Select frame.

Separatorside:

1. Select coarse grain separator.
2. Select silomodule.
3. Select discharge valve.
4. Select frame.
5. Select hose for connection between vacuum cleaner and separator.
6. Select joint sleeve depending on coarse grain separator and hose.
7. Select cleaning equipment.

Choose how to control your butterfly valve:

1. Electric controlled
 - You need a namur valve, solenoid valve recommended for the ejector size you choose and a suitable control box.
2. Air controlled
 - You need a namur valve...

This content is protected under copyright law, furnished for informational use only, and subject to change without notice. © Nederman Holding AB

2026-06-08









2/12

Nederman

710A, Configurable.

710A, Configurable.

Certificeringen	CE
Applicatie	Granulaten, Grit, Spaanders, Stof

	Item number	Persluchtsbehoefte	[ItemMaxAirFlow]	[ItemNoiselevel]	Max. vacuüm	Gewicht (kg)	Filtertype	Aantal filterelementen	Diameter (mm)	[ItemLength]
	43051002 ^[2]	5,4 Nm ³ /min @ 7 bar	690 Nm ³ /h	78	-48	18				
	43051003 ^[2]	8,6 Nm ³ /min @ 7 bar	660 Nm ³ /h	78	-68	18				
	43164101					55	Kaars filter	70		
	43461007									
	43752001									
	43756001 ^[3]									
	43756100 ^[3]									
	43757001 ^[4]									

This content is protected under copyright law, furnished for informational use only, and subject to change without notice. © Nederman Holding AB

2026-06-08

4/12

Nederman

710A, Configurable.

Models

	Item number	Persluchtsbehoefte	[ItemMaxAirFlow]	[ItemNoiselevel]	Max. vacuüm	Gewicht (kg)	Filtertype	Aantal filterelementen	Diameter (mm)	[ItemLength]
	43834100				61				76	5

^[1] Recommended with filtermodule 43162101

^[2] Recommended with filtermodule 43164101

^[3] Each configuration needs the quantity of three legs, so to get a complete product you need to order three pieces of chosen number

^[4] To be used with 43756100, order three pieces

This content is protected under copyright law, furnished for informational use only, and subject to change without notice. © Nederman Holding AB













2026-06-08

5/12

Nederman

710A, Configurable.

Accessories

	Accessory	Item number
	Discharge valve manual	43630001
	Pinch valve DN65	43632001
	Manual butterfly valve kit, MFC	43630400
	Pinch valve DN80	43632100
	Pinch valve DN100	43632200
	Disch valve w/counterwt	43630200
	Discharge valve pneum	43630100
	Discharge valve Linatex d100 set w/	43630300
	Bagholder f/0920220/230	43640001
	Bagholder f/0920210	43640003
	Bagholder f/big bag	43640201
	Bagholder for big bag, MFC	43640217
	Control S for NE 22-76, wo/control box	43220026



This content is protected under copyright law, furnished for informational use only, and subject to change without notice. © Nederman Holding AB













2026-06-08

6/12













Nederman

710A, Configurable.













Accessories

	Accessory	Item number
	Control S for NE86-96, wo/control box	43222008
	Control S for NE 22-76	43220001
	Electrical Control system for ejector NE 86 (Suction time: 0-5 min, Discharge time: 0-15 sek)	43222001
	Mountingplate f/0802010 +0801020	43690001
	Zuigslang PU12 Ø 51 mm L=10m	43832600
	Zuigslang PU12 Ø 51 mm L=5m	43832500
	Zuigslang PU12 Ø 51 mm L=20m	43832300
	Zuigslang PU12 Ø 51 mm L=7,5m met koppelingen	43832102
	Hose PU12-51 L=10m w. couplers	43832200
	Zuigslang PU12 Ø 63 mm L=5m	43833200
	Zuigslang PU12 Ø 63 mm L=10m	43833001
	Zuigslang PU12 Ø 63 mm L=20m	43833100
	Zuigslang PU12 Ø 76 mm L=10m	43834200













Accessories

	Accessory	Item number
	Zuigslang PU12 Ø 76 mm L=20m	43834300
	Reinigingsset compleet Ø51 mm / 500 mm	42932100
	Reinigingsset compleet Ø51 mm / 400 mm	42932800
	Reinigingsset compleet Ø51 mm / 400 mm	42932300
	Vloerzuigmond Ø51 mm, 500 mm breed	43840150
	Vloerzuigmond Ø51 mm, 400 mm breed	43840250
	Vloerzuigmond met borstels, Ø51 mm, 400 mm breed	43840550
	Handmondstuk, harde borstel d51	43860001
	Handmondstuk pp d51	43861001
	Conisch mondstuk d51	43862001
	Elleboogpijp Ø 51 mm antistatisch	43842150
	Zuigbuis Ø51 mm, PEHD-EL 1 meter	43842001
	Harde borstel met handgreep d51	43850150

Accessories

	Accessory	Item number
	Harde borstel d51	43850001
	Schraapgereedschap L=1000mm Ø 51 mm	43851150
	Schraapgereedschap L=500mm Ø 51 mm	43851050
	Spaanmondstuk Ø 50 mm	40150030
	Vloerzuigkop 500 mm breed, Ø 63	43840400
	Harde borstel d63	43850050
	Harde borstel d63 handvat	43850051
	Harde borstel met handgreep d63	43850200
	Schraapgereedschap L=1000mm Ø 63 mm	43851200
	Aluminium bocht Ø63	43843050
	Stalen draaikoppeling d63	43843100
	Aluminium zuigleiding Ø63	43843001
	Schraapgereedschap L=500mm Ø 63 mm	43851100

Accessories

	Accessory	Item number
	Harde borstel d76	43850100
	Harde borstel met handgreep d76	43850250
	Schraapgereedschap L=1000mm Ø 76 mm	43851250
	Conisch rode slang d76-63	43880350
	Conisch verloopstuk d76-51, inclusief klep 43885001	43880300
	Conisch rode slang d63-51	43880250
	Slangkoppeling d63	43880100
	Slangkoppeling d50	43880050
	ATEX-goedgekeurde stofbakniveau-indicator voor veilige bewaking in gevaarlijke omgevingen met gedetailleerde gebruikersinstructies.	40375269
	Joint sleeve d98-114/d70-88	43884462
	Conisch slangkoppeling d76	43880150
	Vloerzuigkop 600 mm breed, Ø 63	43840450

This content is protected under copyright law, furnished for informational use only, and subject to change without notice. © Nederman Holding AB

2026-06-08

10/12

Nederman

710A, Configurable.



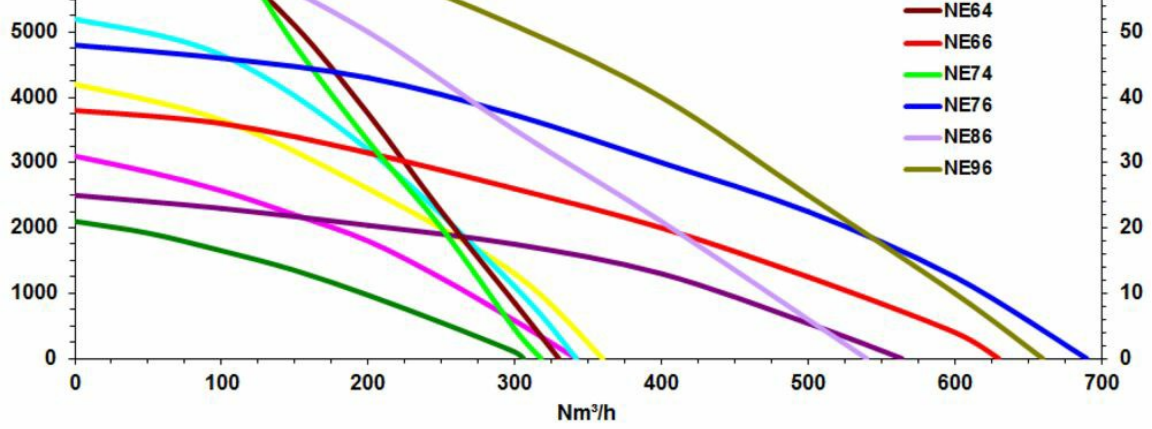

Air Powered ejectors All performance data are based on 7 bar supply pressure

Ejector/Hose dimension	ø51mm	ø63mm	ø76mm
NE64	2	2,4	N/A
NE74	2,3	2,7	N/A
NE76	1,7	2,7	3,6
NE96	2,6	3,6	4,9

Capacity (tonne/hour) with Blasting media 2,4kg/liter and 20m hose

This content is protected under copyright law, furnished for informational use only, and subject to change without notice. © Nederman Holding AB

2026-06-08

11/12

Nederman

710A, Configurable.

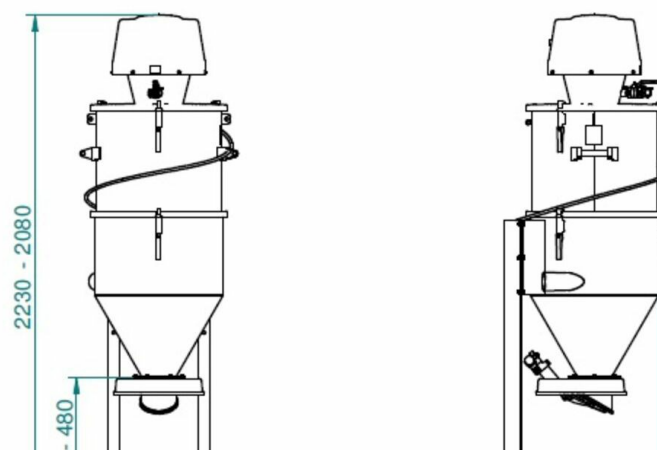



Dimensions - Filter part

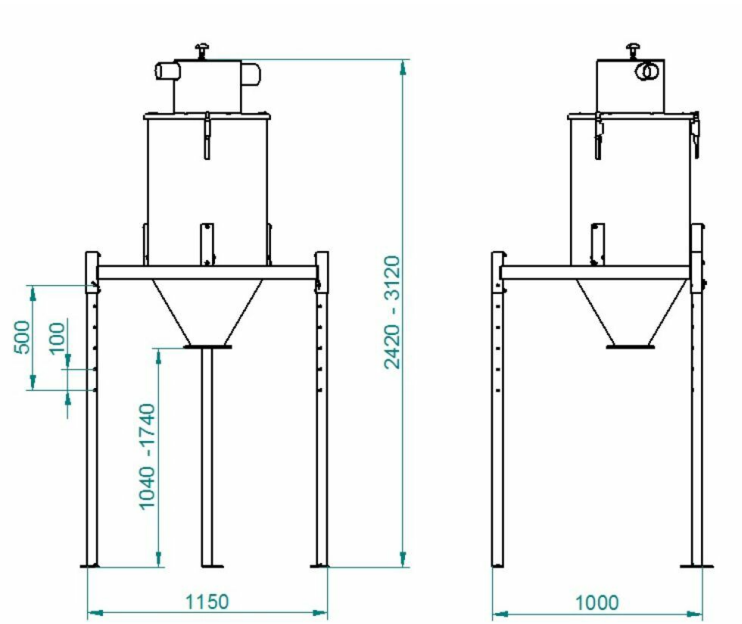

Dimensions pre-separation part