

710A, Configurable.

A powerful dust collector, excellent high vacuum for suction over long horizontal and vertical distance



This content is protected under copyright law, furnished for informational use only, and subject to change without notice. © Nederman Holding AB

2026-06-08

1/12

710A, Configurable.

- ✓ Robust and efficient self-cleaning filter

- ✓ Very powerful and reliable ejector as vacuum producer
- ✓ Suitable for heavy and/or abrasive material
- ✓ Control system with many different functions is available as an accessory

Nederman Pre-separation and Vacuum Transportation Systems pre-separate and discharge dust and granulated material during vacuuming and vacuum transport.

A system can handle dry material like cement, fertilizers, grit, sand, as well as wet material. Collected material can be discharged into tanks, containers, big-bags, on to conveyor belts, escalators etc.

The configuration of modules will be similar to 710A which are aimed for the toughest applications, for example handling a lot of abrasive and heavy material. The robustness of the unit and the power from the reliable ejector makes the unit very suitable for many applications where many industrial vacuum cleaners can not be used. For example to collect blasting material in blasting hall, sand recovery in foundries etc.

Your unit can be configured to meet your specific demands. Different ejectors can be used depending on the demand but also the availability of compressed air. The ejector can be placed on a stationary silo with filter.

Nederman has a range of different discharge valves that can be fitted to the silo for easy discharge of the collected material.

If handling larger quantities of material and in order to make the material handling more effective Nederman recommends using a pre separator before the vacuum unit. The 710A is a complete unit including a pre separator.

To configure your 710A you may only choose modules listed in this document and with mfc (module for configuration) in title.

Filterside:

1. Select ejectormodule depending on required vacuum and air flow.
2. Select filtermodule depending on filter capacity.
3. Select silomodule.
4. Select disposal option, bagholder and discharge valve.
5. Select frame.

Separatorside:

1. Select coarse grain separator.
2. Select silomodule.
3. Select discharge valve.
4. Select frame.
5. Select hose for connection between vacuum cleaner and separator.
6. Select joint sleeve depending on coarse grain separator and hose.
7. Select cleaning equipment.

Choose how to control your butterfly valve:

1. Electric controlled
 - You need a namur valve, solenoid valve recommended for the ejector size you choose and a suitable control box.
2. Air controlled
 - You need a namur valve...

This content is protected under copyright law, furnished for informational use only, and subject to change without notice. © Nederman Holding AB

2026-06-08

2/12

Nederman

710A, Configurable.

710A, Configurable.

Certifications	CE
[ProductApplication]	Granulé, Abrasif, Copeau, Poussière

This content is protected under copyright law, furnished for informational use only, and subject to change without notice. © Nederman Holding AB









2026-06-08





3/12

Nederman

710A, Configurable.

Models

	Item number	[ItemCompressedAirRequirement]	[ItemMaxAirFlow]	olume sonore (dB(A))	[ItemMaxVaccum]	Poids (kg)	Type de filtre	Nombre d'éléments filtrants	[ItemDiameter]	[ItemLength]
	43051000 ^[1]	4,3 Nm ³ /min @ 7 bar	330 Nm ³ /h	77	-68	18				
	43750001									
	43441001									
	43561001									
	43661008									
	43051002 ^[2]	5,4 Nm ³ /min @ 7 bar	690 Nm ³ /h	78	-48	18				
	43051003 ^[2]	8,6 Nm ³ /min @ 7 bar	660 Nm ³ /h	78	-68	18				
	43164101					55	Filtre à bougie	70		

	Item number	[ItemCompressedAirRequirement]	[ItemMaxAirFlow]	olume sonore (dB(A))	[ItemMaxVaccum]	Poids (kg)	Type de filtre	Nombre d'éléments filtrants	[ItemDiameter]	[ItemLength]
	43461007									
	43752001									
	43756001 ^[3]									
	43756100 ^[3]									
	43757001 ^[4]									

This content is protected under copyright law, furnished for informational use only, and subject to change without notice. © Nederman Holding AB

2026-06-08

4/12

Nederman

710A, Configurable.

Models

	Item number	[ItemCompressedAirRequirement]	[ItemMaxAirFlow]	olume sonore (dB(A))	[ItemMaxVaccum]	Poids (kg)	Type de filtre	Nombre d'éléments filtrants	[ItemDiameter]	[ItemLength]
	43834100			61				76		5













^[1] Recommandé avec le module de filtre 43162101

^[2] Recommandé avec le module de filtre 43164101

^[3] Chaque configuration nécessite trois pieds. Ainsi, pour obtenir le produit entier souhaité, vous devez commander trois éléments du nombre choisi

^[4] À utiliser avec 43756100, commander trois pièces













Accessories

	Accessory	Item number
	Vanne de décharge manuelle	43630001
	Vanne d'étranglement DN65	43632001
	Ensemble vanne papillon, MFC	43630400
	Vanne d'étranglement DN80	43632100
	Vanne d'étranglement DN100	43632200
	Vanne déch. av. contrepoids	43630200
	Vanne de décharge pneum.	43630100
	Kit Vanne de décharge Linatex d100 av.	43630300
	Support sac pour 0920220/230	43640001
	Support sac p. 0920210	43640003
	Support pour grand sac	43640201
	Bagholder for big bag, MFC	43640217
	Commande S for NE 22-76, sans boîtier de commande	43220026

Nederman

710A, Configurable.













Accessories

	Accessory	Item number
	Commande Sfor NE 86	43222008
	Commande S pour NE 22-76	43220001
	Système de commande électrique pour éjecteur NE 86. (temps d'aspiration : 0 - 5 min., temps de décharge : 0-15 sec.)	43222001
	Plaque de montage pour 0802010/+0801020	43690001
	Tuyau PU12-51 L=10m	43832600
	Tuyau PU12-51 L=5m	43832500
	Tuyau PU12-51 L=20m	43832300
	Tuyau PU12-51 L=7,5 m a. raccords	43832102
	Tuyau PU12-51 L=10 m a. raccords	43832200
	Tuyau PU12-63 L=5m	43833200
	Tuyau PU12-63 L=10m	43833001
	Tuyau PU12-63 L=20m	43833100
	Tuyau PU12-76 L=10m	43834200

Nederman

710A, Configurable.

Accessories

	Accessory	Item number
	Tuyau PU12-76 L=20m	43834300
	Équip. d'asp. compl. d51/500	42932100
	Équip. d'asp. compl. d51/400	42932800
	Équip. d'asp. compl. d51/400	42932300
	Tête d'aspiration sol d51/500	43840150
	Tête d'aspiration sol 51/400/65	43840250
	Tête d'aspiration brosse d51/400	43840550
	Tête d'asp. man. rigide brushd51	43860001
	Tête d'aspiration manuelle pp d51	43861001
	Buse conique d51	43862001
	Conduite d'asp. coudé d51 antistat.	43842150
	Conduite d'aspiration d51 PEHD-el 1 m	43842001
	Brosse dure d51 avec poignée	43850150

This content is protected under copyright law, furnished for informational use only, and subject to change without notice. © Nederman Holding AB



2026-06-08











8/12

Nederman

710A, Configurable.

Accessories

	Accessory	Item number
	Brosse dure d51	43850001
	Outil racleur d51 I1000	43851150
	Outil racleur d51 I500	43851050

	Accessory	Item number
	Buse copeaux D=50 mm	40150030
	Tête d'aspiration sol d63/500	43840400
	Brosse dure d63	43850050
	Brosse dure d63 manche	43850051
	Brosse dure d63 avec poignée	43850200
	Outil racleur d63 I1000	43851200
	Conduite d'asp. coudé alum d63	43843050
	Rotule acier d63	43843100
	Conduite d'aspiration alum. d63	43843001
	Outil racleur d63 I500	43851100

This content is protected under copyright law, furnished for informational use only, and subject to change without notice. © Nederman Holding AB

2026-06-08





9/12

Nederman

710A, Configurable.

Accessories

	Accessory	Item number
	Brosse dure d76	43850100
	Brosse dure d76 avec poignée	43850250
	Outil racleur d76 I1000	43851250
	Tuyau rouge conique d76-63	43880350
	Réd. conique d76-51	43880300
	Tuyau rouge conique d63-51	43880250
	Connecteur de tuyau d63	43880100
	Connecteur de tuyau d50	43880050

	Accessory	Item number
	BLI EX	40375269
	Manchon raccord d98-114/d70-88	43884462
	Connecteur de tuyau conique d76	43880150
	Tête d'aspiration sol d63/600	43840450

This content is protected under copyright law, furnished for informational use only, and subject to change without notice. © Nederman Holding AB

2026-06-08

10/12

Nederman

710A, Configurable.

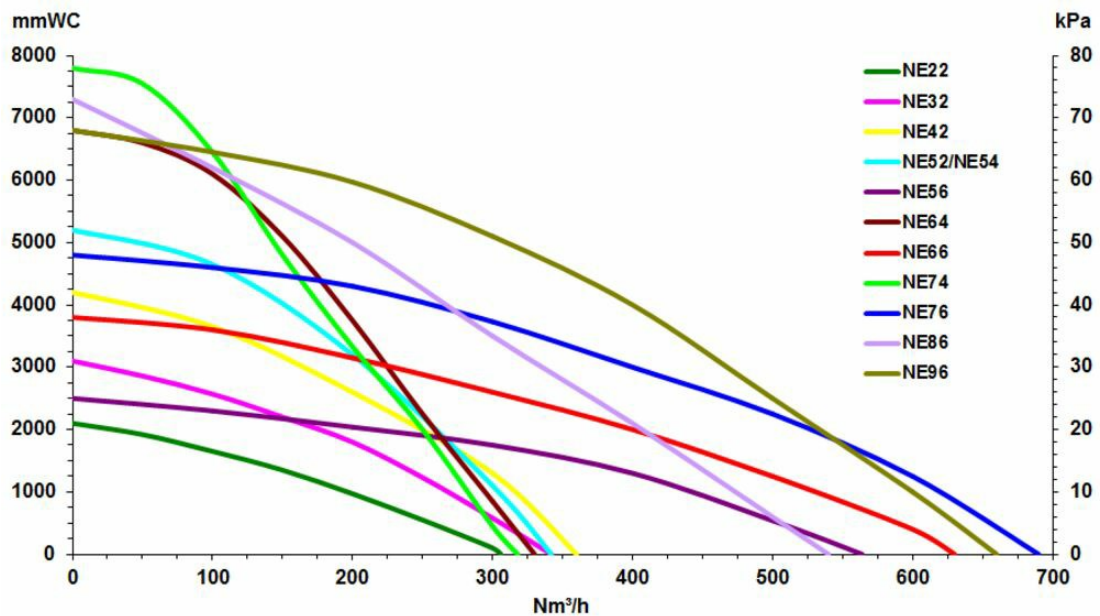

Air Powered ejectors All performance data are based on 7 bar supply pressure

Ejector/Hose dimension	ø51mm	ø63mm	ø76mm
NE64	2	2,4	N/A
NE74	2,3	2,7	N/A
NE76	1,7	2,7	3,6

This content is protected under copyright law, furnished for informational use only, and subject to change without notice. © Nederman Holding AB

2026-06-08

11/12

Nederman

710A, Configurable.

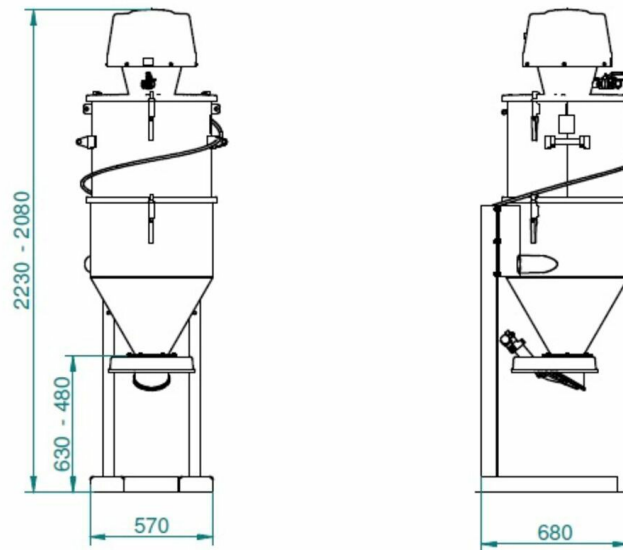

Dimensions - Filter part

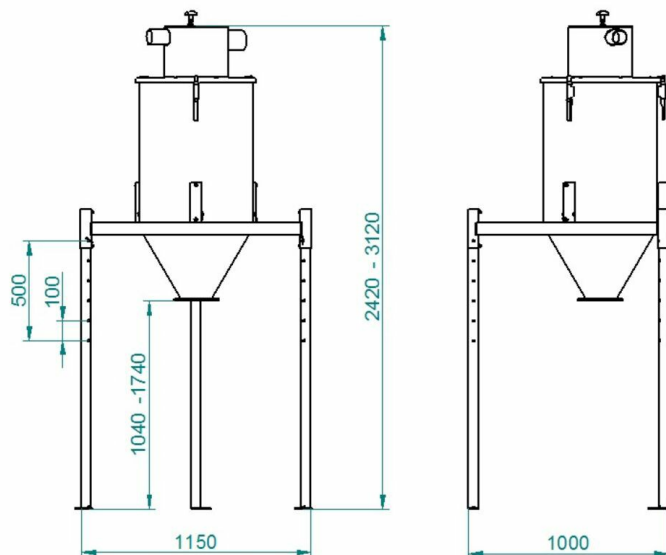

Dimensions pre-separation part

