

QF adapters and accessories

Adapters and various accessories for QF ducting systems











QF adapters and accessories







QF adapters and accessories

End Type A	QF
Length	58

Models

	Item no	Diameter A	Inner dimension (ID)	Outer dimension (OD)	Rolled Edge (mm)
	8210000019	80	78	79	6
	8210000020	100	97	98	6
	8210000021	125	123	124	6
	8210000022	140	138	139	6
	8210000023	150	147	148	6
	8210000024	160	158	159	6
	8210000025	180	178	179	8
	8210000026	200	199	200	8
	8210000027	224	223	224	8
	8210000028	250	249	250	8
	8210000029	300	297	298	10
	8210000030	315	312	313	10
	8210000031	350	347	348	10

Models

	Item no	Diameter A	Inner dimension (ID)	Outer dimension (OD)	Rolled Edge (mm)
	8210000032	400	398	400	10
	8210000033	450	447	449	10
	8210000034	500	497	499	
	8210000035	560	557	559	
	8210000036	630	627	629	
	8210000037	710	707	709	

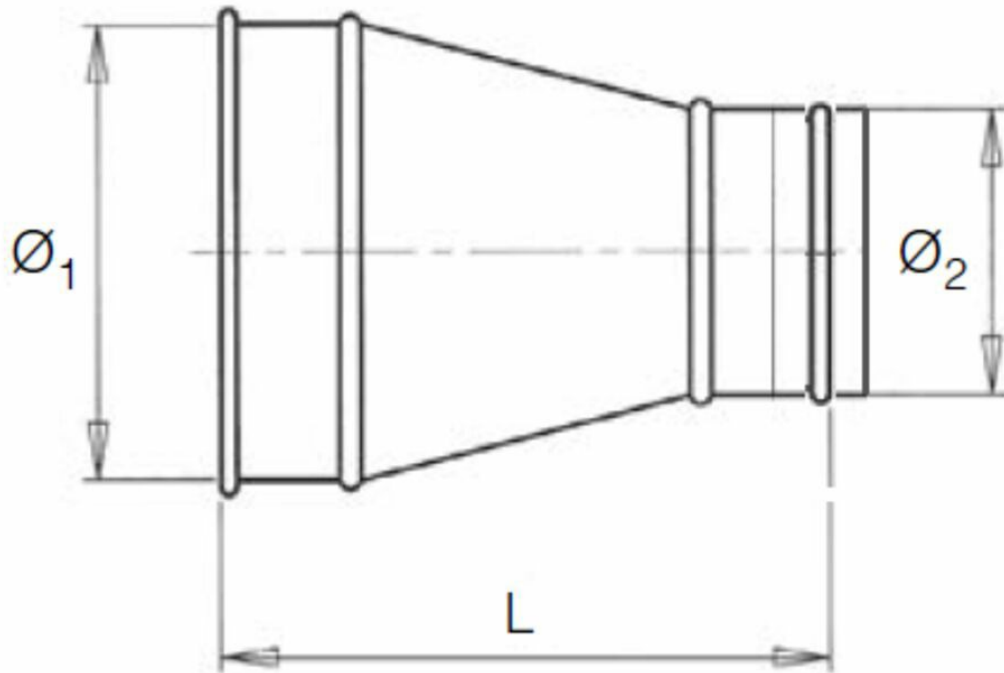

QF Cone for hose connection dimensions

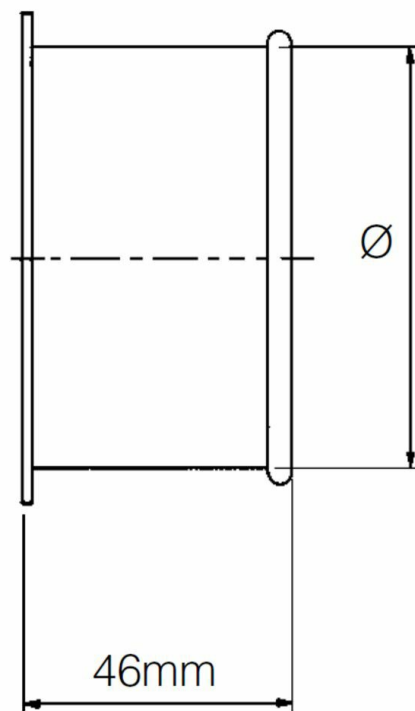

QF Tabular rivet adapter dimensions

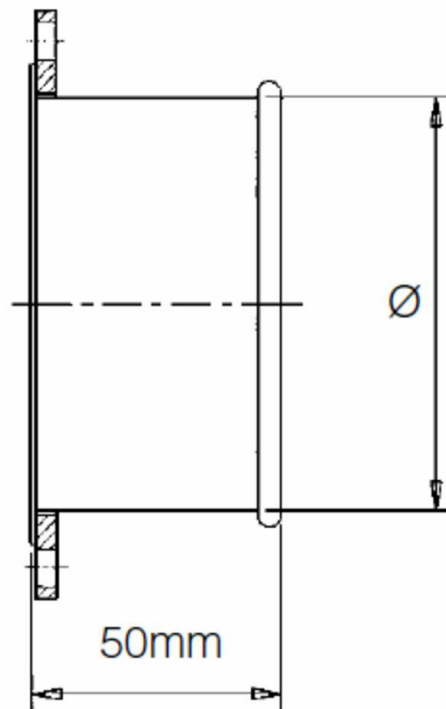

QF Flanged adapter dimensions

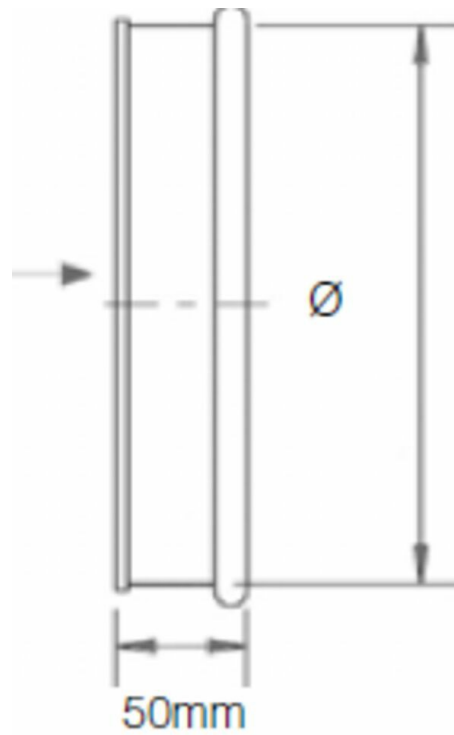

QF End Cap Dimensions, 22012-XXX

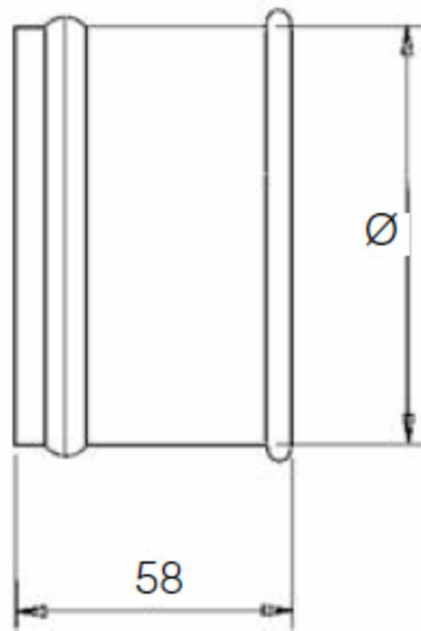

QF Hose adapter dimensions

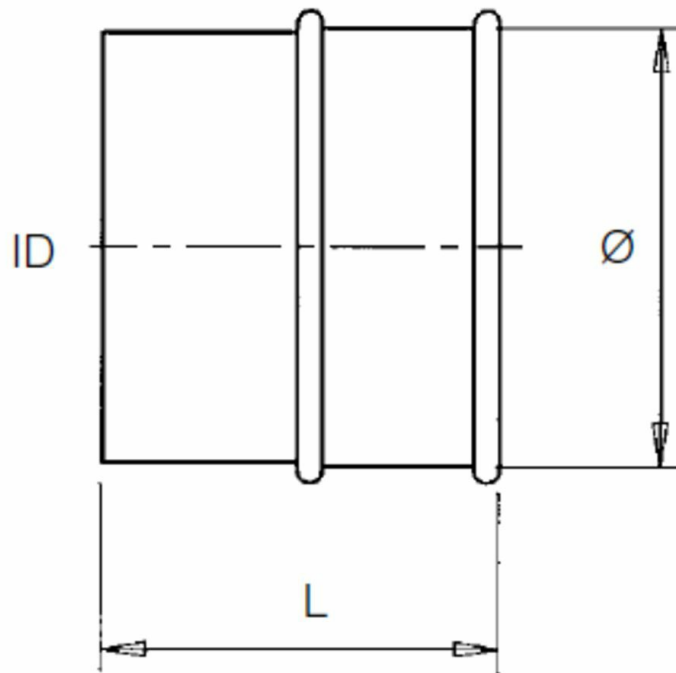

QF Ventilation adapter

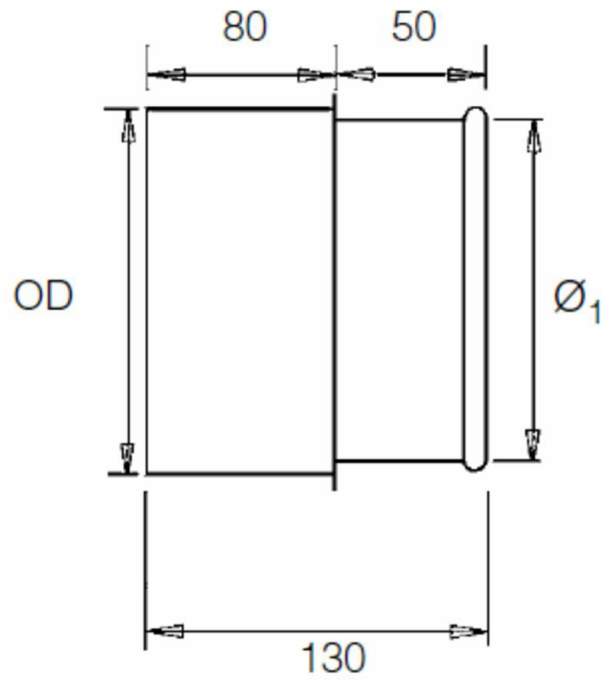

QF Machine adapter dimensions

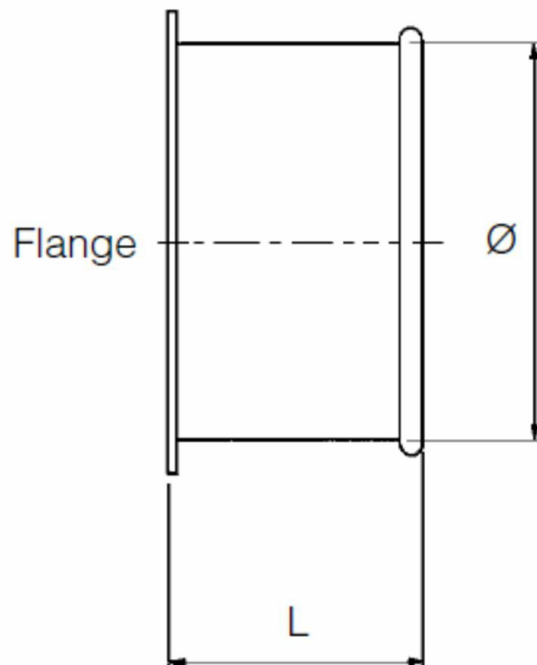

QF Transition Piece Dimensions

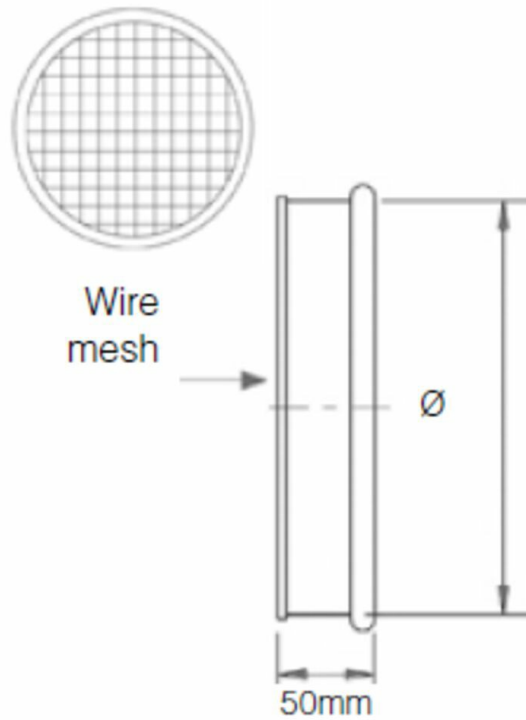

QF Mesh End Cap Dimensions