

Fan N16, Single phase



Fan N16, Single phase

- ✓ Compact
- ✓ Easy to use

A centrifugal fan mainly designed for use with Nederman extraction products.

Note! The fan must not be used in an environment with danger of explosion or for transport of inflammable or explosive gases.













Fan N16, Single phase

[ProductCertifications]	[ce]
[ProductInstallation]	Interior, Exterior
[ProductApplication]	Polvo, Humos
[ItemPowerVoltage]	115/230
[ItemFrequency]	60
[ItemNoofphases]	1
[ItemAmperage]	6,6
[ItemWeight]	14,5
[ItemPower]	0,55









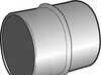
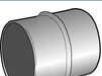
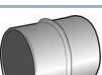

Modelos

	No. De Artículo
	14510321

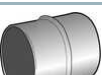



Accesorios

	Accesorio	No. De Artículo
	Fan Control Man 1~ 1-5A	14518837
	Fan Control Autom 1~ 1-5A	14519237
	Reducer. diam.125/100mm.	14341077
	Reducer. diam.125/75mm. black.	14341080
	Reducer inside diam=160mm. outside	14510426
	Reducer inside diam=160mm. outside	14510526
	Reducer inside diam=160mm. outside	14510626
	Adapter. diam 160/150mm.	14511226
	Adapter diam.=160mm.	14510326
	In- and outlet connection with	14322166
	Guard net for fan N16 and N24.	14333181
	Pvc-hose. diam.100mm.L=5m	10500427
	Pvc-hose. diam.5". l=5m.	10500527

Accesorios

	Accesorio	No. De Artículo
	Pvc-hose, diam.6". l=5m.	10500627
	Pvc-hose diam. 160mm.L=5m	10511026
	Connector 3"-3". (75mm).	14503626
	Connector 4"-4". (100mm).	14504626
	Connector 5"-5". (125mm).	14505626
	Connector 6"-6". (150mm).	14506626
	Adapter diam=160mm	14511326
	Nozzle, silumin. with magnet.	14500226
	Nozzle, plastic. with magnet.	14501226
	Exhaust silencer for fan	14502126
	Silencer for fan	14502626
	Silencer including quick release	14502226
	Wall bracket for silencer, pair.	14343089

Accesorios

	Accesorio	No. De Artículo
	Double adapter. diam.125mm/2x125mm.	14500726
	Split intake(t-tube).	14510726
	Double adapter. diam.125mm/2x75mm.	14500826
	Support bracket for N10/N16/N24 for fixed mounting. Incl guard net and inlet connection.	14510126
	Bracket for serial N16 and N24 portable	14511426

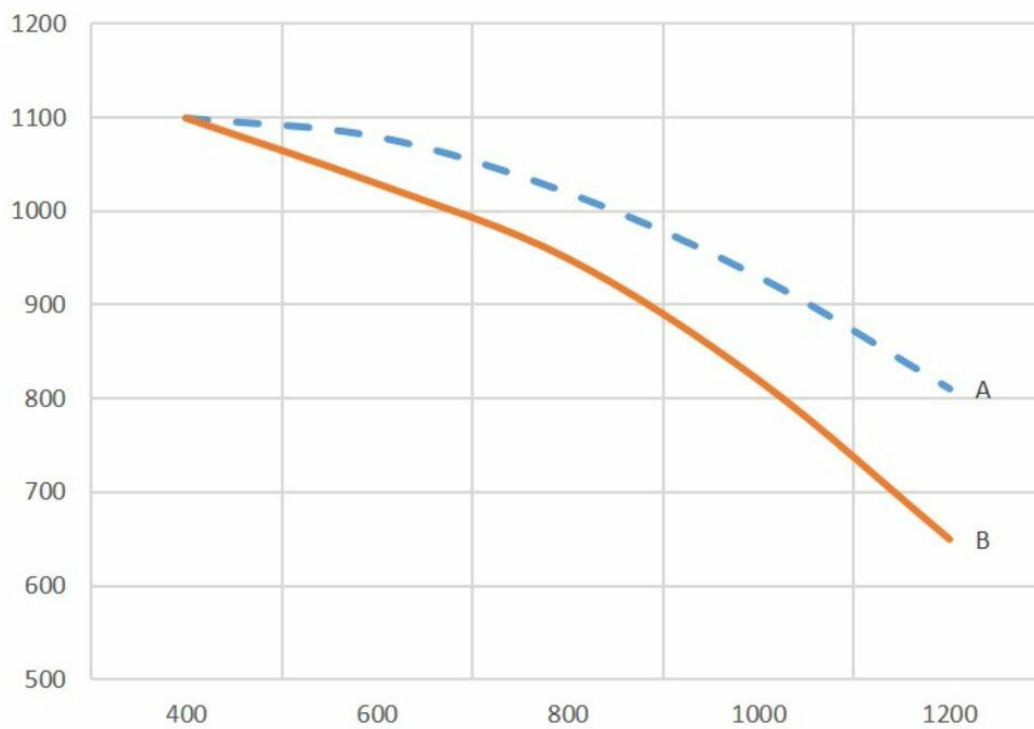
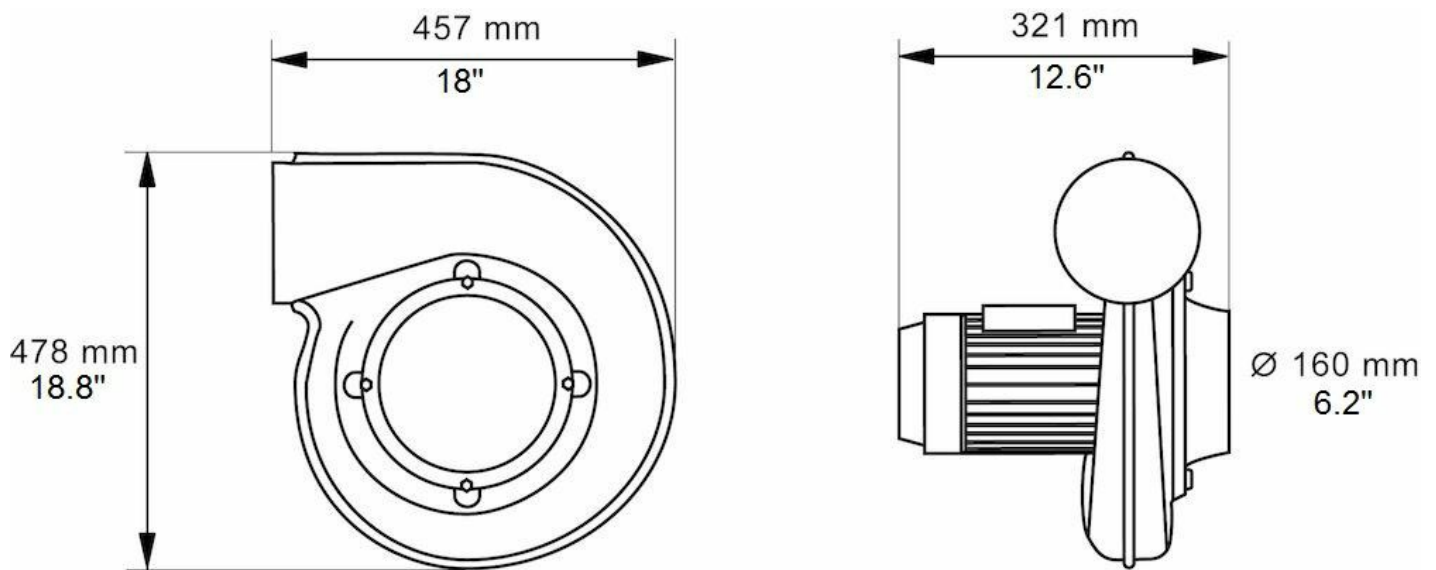

A: Fan total Pressure B: Fan Static Pressure X: m³/h Y: Pa