

Producto leaflet

Fan N16, 3 phases



Fan N16, 3 phases

- ✓ Compact
- ✓ Easy to use



A centrifugal fan mainly designed for use with Nederman extraction products.

Note! The fan must not be used in an environment with danger of explosion or for transport of inflammable or explosive gases.













Fan N16, 3 phases

| | |
|---------------------------------|-------------------------------|
| [ProductCertifications] | [ce] |
| [ProductInstallation] | Interior, Exterior |
| [ProductAmbienTemperatureRange] | -30 to +40 C (-22 F to 104 F) |
| [ItemFrequency] | 60 |
| [ItemNoofphases] | 3 |
| [ItemPower] | 0,55 |









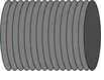
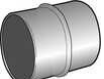

Modelos

| | No. De Artículo | [ItemPowerVoltage] | [ItemAmperage] | [ItemWeight] |
|---|-----------------|--------------------|----------------|--------------|
|  | 14511021 | 230/460 | 2,4/1,2 | 14,3 |
|  | 14513021 | 575 | 1,1 | 12,4 |





Accesorios

| | Accesorio | No. De Artículo |
|---|------------------------------------|-----------------|
|  | Fan Control Man 3~ 1-5A | 14518637 |
|  | Fan Control Autom 3ph 1-5A | 14519037 |
|  | Reducer. diam.125/100mm. | 14341077 |
|  | Reducer. diam.125/75mm. black. | 14341080 |
|  | Reducer inside diam=160mm. outside | 14510426 |
|  | Reducer inside diam=160mm. outside | 14510526 |
|  | Reducer inside diam=160mm. outside | 14510626 |
|  | Adapter. diam 160/150mm. | 14511226 |
|  | Adapter diam.=160mm. | 14510326 |
|  | In- and outlet connection with | 14322166 |
|  | Guard net for fan N16 and N24. | 14333181 |
|  | Pvc-hose. diam.100mm.L=5m | 10500427 |
|  | Pvc-hose. diam.5". l=5m. | 10500527 |

Accesorios

| | Accesorio | No. De Artículo |
|--|----------------------------------|-----------------|
|  | Pvc-hose. diam.6". l=5m. | 10500627 |
|  | Pvc-hose diam. 160mm.L=5m | 10511026 |
|  | Connector 3"-3". (75mm). | 14503626 |
|  | Connector 4"-4". (100mm). | 14504626 |
|  | Connector 5"-5". (125mm). | 14505626 |
|  | Connector 6"-6". (150mm). | 14506626 |
|  | Adapter diam=160mm | 14511326 |
|  | Nozzle. silumin. with magnet. | 14500226 |
|  | Nozzle. plastic. with magnet. | 14501226 |
|  | Exhaust silencer for fan | 14502126 |
|  | Silencer for fan | 14502626 |
|  | Silencer.Including quick release | 14502226 |
|  | Wall bracket for silencer, pair. | 14343089 |

Accesorios

| | Accesorio | No. De Artículo |
|---|--|-----------------|
|  | Double adapter. diam.125mm/2x125mm. | 14500726 |
|  | Split intake(t-tube). | 14510726 |
|  | Double adapter. diam.125mm/2x75mm. | 14500826 |
|  | Support bracket for N10/N16/N24 for fixed mounting. Incl guard net and inlet connection. | 14510126 |
|  | Bracket for serial N16 and N24 portable | 14511426 |

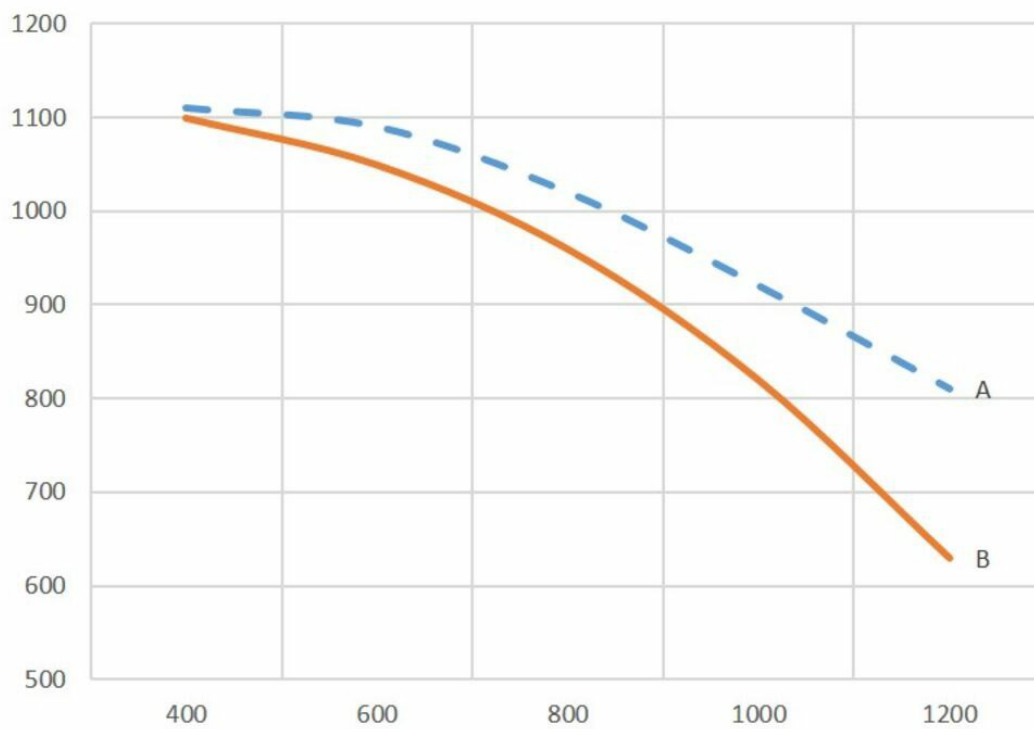
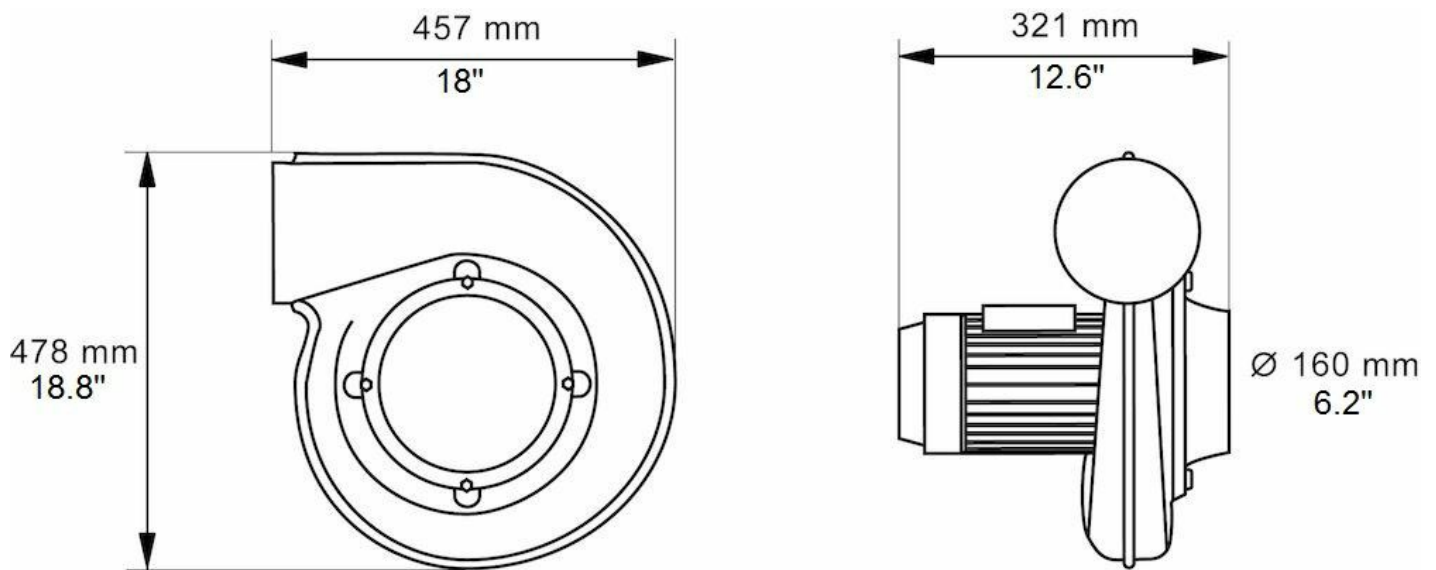

A: Fan total Pressure B: Fan static Pressure X: m³/h Y: Pa