

ข้อมูลผลิตภัณฑ์

พัดลมขับเคลื่อนโดยตรง NCF 50 Hz













พัดลมขับเคลื่อนโดยตรง NCF 50 Hz

พัดลม NCF ของเนเดอร์แมนมีมอเตอร์ขับเคลื่อนโดยตรง ซึ่งหมายความว่า มีการปฏิบัติการที่มีประสิทธิภาพด้านค่าใช้จ่ายและความปลอดภัย การติดตั้งพัดลม NCF ที่มีประสิทธิภาพด้านพลังงานกับผลิตภัณฑ์อื่นๆ ของเนเดอร์แมนจะช่วยประหยัดเวลาและลดค่าใช้จ่ายด้านพลังงาน เป็นพัดลมแบบแรงเหวี่ยงที่ออกแบบมาสำหรับใช้ในกระบวนการผลิตและระบบระบายอากาศทุกประเภทติดตั้งภายในอาคารและกลางแจ้ง พัดลมมีใช้คือฟเป็นแบบมาตรฐาน













พัดลมขับเคลื่อนโดยตรง NCF 50 Hz

[ProductCertifications]	CE
[ProductProtectionclass]	IP55
[ProductInstallation]	นอกอาคาร, ในอาคาร
[ProductAmbienTemperatureRange]	-30 to +40 °C (22 F to 104 F)
[ItemFrequency]	50
[ItemNoofphases]	3

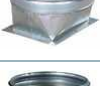
รุ่น

	เลขที่สินค้า	[ItemPowerVoltage]	[ItemAmperage]	[ItemWeight]	[ItemPower]
	14550228	230/400	24,0/13,8	123	7,5
	14550128	230/400	7,9 / 4,6	67	2,2
	14550528	230/400	17,9/10,3	112	5,5
	14550728	230/400	46,1/26,5	232	15
	14550828	230/400	56,5/32,5	292	18,5
	14550928	400/690	13,8/8,0	123	7,5
	14551028	400/690	7,8/4,5	105	4
	14551228	400/690	10,3/6,0	112	5,5
	14551328	400/690	13,8/8,0	150	7,5
	14551428	400/690	26,5/15,3	232	15
	14551528	400/690	32,5/18,8	292	18,5



อุปกรณ์เสริม

	อุปกรณ์เสริม	เลขที่สินค้า
	Inlet adap. d250,30/15,40/25,50/25	14374438
	Inlet adapter d315, 30/25	14374439
	Inlet adapter d400, 80/20, 120/25	14374440
	Inlet adapter d500, 120/15, 160/25	14374441
	Outl. adap.288x205 d315,30/15,40/25	14374442
	Outlet adapter 322x229 d400, 30/25	14374443
	Outl.adap.361x256 d400,80/20,120/25	14374444
	Outl.adap.256x183 d250, 50/25,30/20	14374446
	Flex.inl.ad..d250,30/15,40/25,50/25	14374447
	Flexible inlet adapter d315, 30/25	14374448
	Flex.inlet.adap.d400, 80/20, 120/25	14374449
	Flex.inlet.adap.d500,120/15,160/25	14374450
	Flex.out.a.288x205 d315,30/15,40/25	14374451

อุปกรณ์เสริม

	อุปกรณ์เสริม	เลขที่สินค้า
	Flex.out.a.361x256d400,80/20,120/25	14374453
	Flex.ou.a.453x322d500,120/15,160/25	14374454
	Inlet guard net d400, 80/20, 120/25	14374458
	Inlet guard net d500,120/15,160/25	14374459
	Outlet guard net, 30/15, 40/25	14374460
	Outlet guard net, 80/20, 120/25	14374462
	Outlet guard net, 120/15, 160/25	14374463
	Vibration absorber AM 30, 1 set	14374628
	Vibration absorber AM 25, 1 set	14374629
	Vibration absorber AM 50, 1 set	14374630
	อินเวอร์เตอร์พัดลม 5.5	14522037
	อินเวอร์เตอร์พัดลม 7.5	14522137
	อินเวอร์เตอร์พัดลม 11	14522237

อุปกรณ์เสริม

	อุปกรณ์เสริม	เลขที่สินค้า
	อินเวอร์เตอร์พัดลม 15	14522637
	อินเวอร์เตอร์พัดลม 18.5	14525137
	Fan inverter 22	14525237

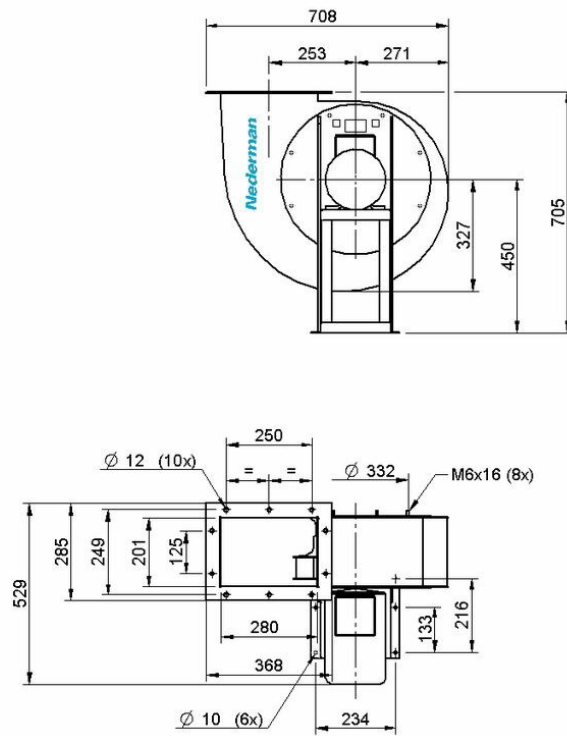

NCF 30/15 Duct inlet diameter 250 mm Duct outlet diameter 315 mm

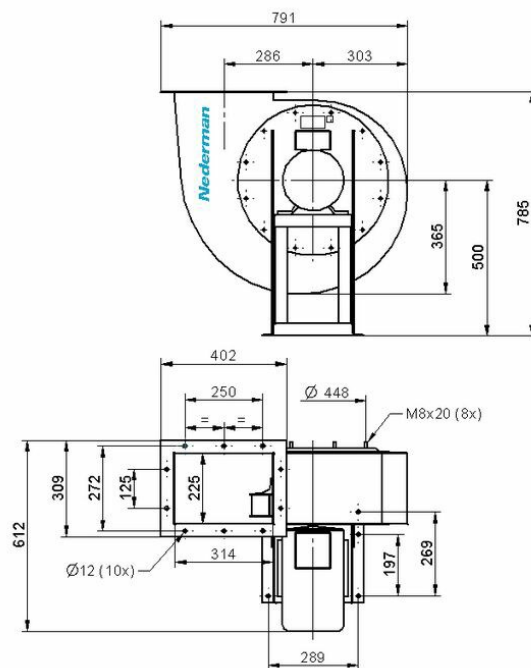

NCF 30/25 Duct inlet diameter 315 mm Duct outlet diameter 400 mm

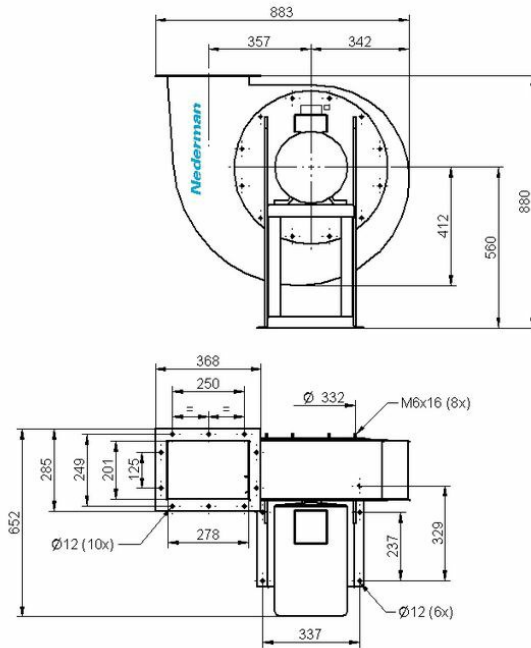

NCF 40/25 Duct inlet diameter 250 mm Duct outlet diameter 315 mm

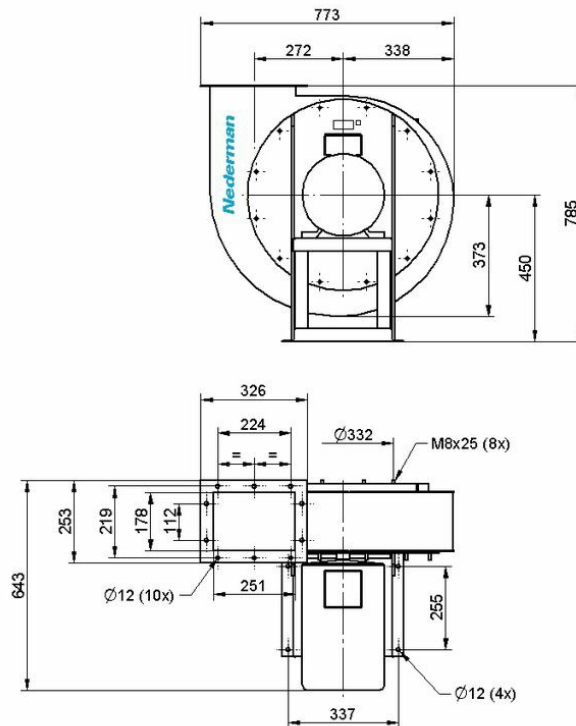

NCF 50/25 Duct inlet diameter 250 mm Duct outlet diameter 250 mm

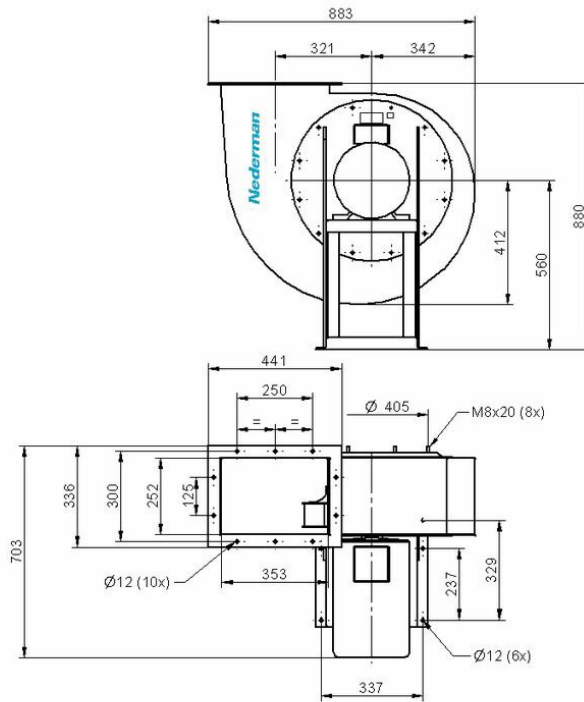

NCF 80/20 Duct inlet diameter 400 mm Duct outlet diameter 400 mm

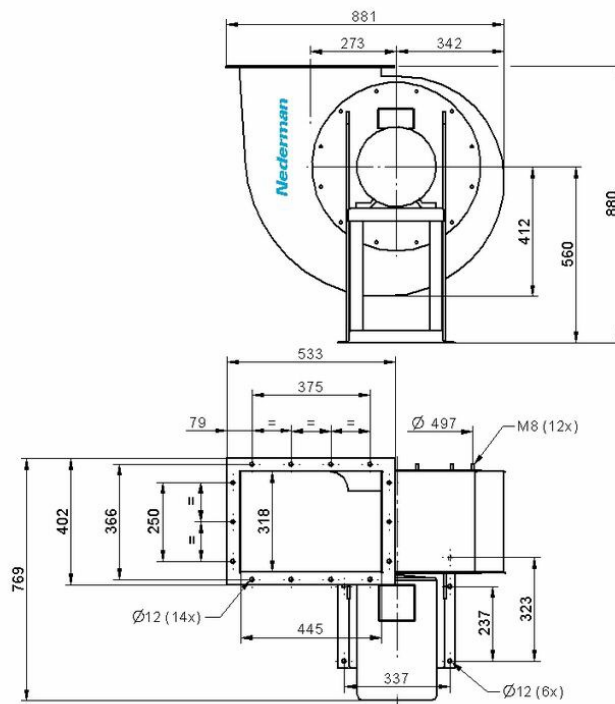

NCF 120/15 Duct inlet diameter 500 mm Duct outlet diameter 500 mm

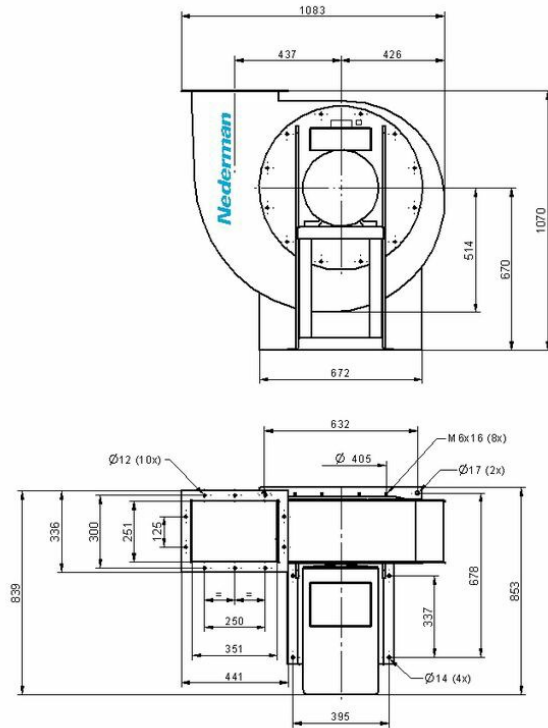

Fan NCF 120/25 Duct inlet diameter 400 mm Duct outlet diameter 400 mm

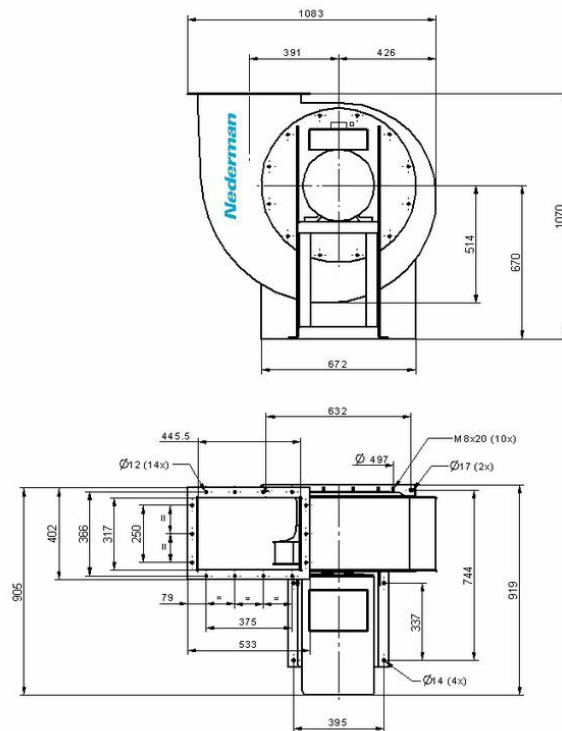

NCF 160/25 Duct inlet diameter 500 mm Duct outlet diameter 500 mm

